

2019
Platné od 1.6.2019

PM-TECH

FRÉZY PRO OBRÁBĚNÍ GRAFITU



DIAMANTOVÝ
POVLAK



SKLADEM
V České republice

Co je důležité vědět o našich frézách na grafit?



DIAMANTOVÝ POVLAK

JE NANÁŠEN V NĚKOLIKA
VRSTVÁCH NEJNOVEJŠÍ
TECHNOLOGIÍ
TVRDOST = 10 000 HV

PRÉMIOVÝ TVRDOKOV
+
DIAMANTOVÝ POVLAK



= KŘEHKÉ
POZOR
při manipulaci

↑ SÍLA POVLAKU
≠
↑ ŽIVOTNOSTI

IDEÁLNÍ TLOUŠŤKA POVLAKU
PRO ZACHOVÁNÍ OSTROTI

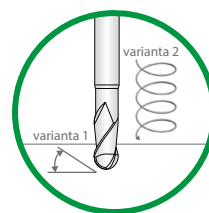
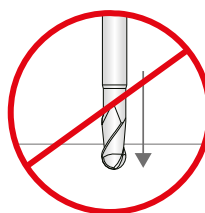

Najíždět do materiálu **POD ÚHLEM**
nebo **KRUHOVOU INTERPOLACÍ**

RYCHLÉ ÚPRAVY NÁSTROJŮ

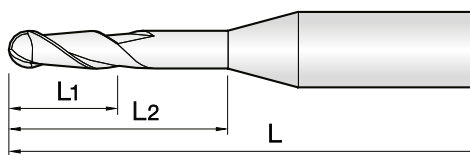

ROZMĚRY FRÉZ
NA SLOŽITÉ 3D TVARY
A ŽEBRA GRAFITOVÝCH
ELEKTROD











PŘEPOVLAKOVÁNÍ
NENÍ z technologických
důvodů **MOŽNÉ**

ROZŠIŘUJÍCÍ SE KATALOG

SPECIÁLY SE MĚNÍ
VE STANDARDY

Výběr a použití fréz

Typ	Provedení	Počet břitů	Rozsah průměrů (mm)	Stránka katalogu
	KULOVÉ	2	Ø0,2 - Ø12	str. 4 - 5
	KULOVÉ	3	Ø1 - Ø12	str. 6
	KULOVÉ	4	Ø1 - Ø12	str. 7
	KULOVÉ	3	Ø1 - Ø4	str. 8
	TOROIDNÍ	2	Ø0,2 - Ø6	str. 9 - 10
	TOROIDNÍ	4	Ø2 - Ø12	str. 11
	OSTRÉ	2	Ø0,2 - Ø12	str. 12
	OSTRÉ	3	Ø1 - Ø12	str. 13
	HRUBOVACÍ	2	Ø4 - Ø12	str. 14

KULOVÉ

TOROIDNÍ

OSTRÉ

HRUBOVACÍ

2DBE 2-břité KULOVÉ frézy pro žebrování a s diamantovým povlakem pro obrábění grafitu, karbonu, vyztužených plastů a ZrO₂

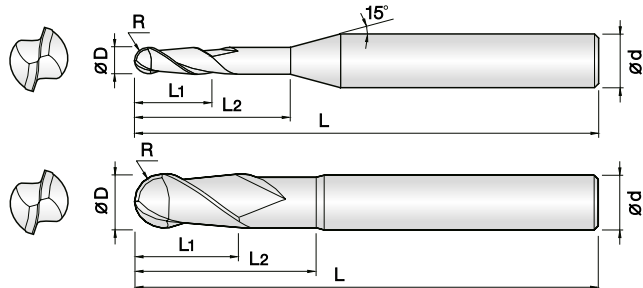

- Určeno pro grafit, karbon, vyztužené plasty a ZrO₂
- Vysoká odolnost proti opotřebení díky CVD diamantovému povlaku
- Široký sortiment rádiusů a vyložení pro optimální výběr nástroje

● - skladová položka
○ - dodání obvykle 2-7 pracovních dnů

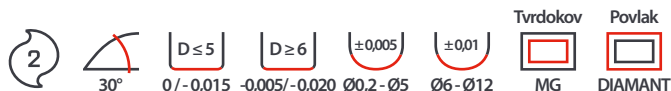

NOVINKA

Objednací číslo	Sklad	D (mm)	R (mm)	L2 (mm)	L1 (mm)	L (mm)	d h5 (mm)	Standardní položka
2DBE-002-010-S04	●	0,2	R0,1	-	1	45	4	☑
2DBE-003-012-S04	●	0,3	R0,15	-	1,2	45	4	☑
2DBE-003-020-S04	○			2	1,2	45	4	☑
2DBE-003-030-S04	●			3	1,2	45	4	☑
2DBE-004-015-S04	●	0,4	R0,2	-	1,5	45	4	☑
2DBE-004-020-S04	●			2	1,5	45	4	☑
2DBE-004-030-S04	●			3	1,5	45	4	☑
2DBE-004-040-S04	●			4	1,5	45	4	☑
2DBE-004-050-S04	○			5	1,5	45	4	☑
2DBE-004-080-S04	●			8	1,5	45	4	☑
2DBE-004-100-S04	○			10	1,5	45	4	☑
2DBE-005-020-S04	●	0,5	R0,25	-	2	45	4	☑
2DBE-005-030-S04	●			3	2	45	4	☑
2DBE-005-040-S04	○			4	2	45	4	☑
2DBE-005-050-S04	●			5	2	45	4	☑
2DBE-005-060-S04	●			6	2	45	4	☑
2DBE-005-080-S04	●			8	2	45	4	☑
2DBE-005-100-S04	●			10	2	45	4	☑
2DBE-005-120-S04	○			12	2	45	4	☑
2DBE-006-020-S04	○	0,6	R0,3	-	2	45	4	☑
2DBE-006-030-S04	●			3	2	45	4	☑
2DBE-006-040-S04	○			4	2	45	4	☑
2DBE-006-050-S04	●			5	2	45	4	☑
2DBE-006-060-S04	●			6	2	45	4	☑
2DBE-006-080-S04	●			8	2	45	4	☑
2DBE-006-100-S04	●			10	2	45	4	☑
2DBE-006-120-S04	●			12	2	45	4	☑
2DBE-006-150-S04	○			15	2	45	4	☑
2DBE-006-200-S04	○			20	2	45	4	☑
2DBE-008-030-S04	○	0,8	R0,4	-	3	45	4	☑
2DBE-008-040-S04	○			4	3	45	4	☑
2DBE-008-050-S04	●			5	3	45	4	☑
2DBE-008-060-S04	○			6	3	45	4	☑
2DBE-008-080-S04	●			8	3	45	4	☑
2DBE-008-100-S04	●			10	3	45	4	☑
2DBE-008-120-S04	●			12	3	45	4	☑
2DBE-008-150-S04	●			15	3	45	4	☑
2DBE-008-200-S04	○			20	3	45	4	☑

Objednací číslo	Sklad	D (mm)	R (mm)	L2 (mm)	L1 (mm)	L (mm)	d h5 (mm)	Standardní položka
2DBE-010-030-S04	○	1	R0,5	-	3	60	4	☑
2DBE-010-040-S04	○			4	3	60	4	☑
2DBE-010-050-S04	●			5	3	60	4	☑
2DBE-010-060-S04	●			6	3	60	4	☑
2DBE-010-080-S04	○			8	3	60	4	☑
2DBE-010-100-S04	●			10	3	60	4	☑
2DBE-010-120-S04	○	1	R0,5	12	3	60	4	☑
2DBE-010-150-S04	●			15	3	60	4	☑
2DBE-010-200-S04	●			20	3	60	4	☑
2DBE-010-250-S04	●			25	3	80	4	☑
2DBE-010-300-S04	●			30	3	80	4	☑
2DBE-010-350-S04	○			35	3	80	4	☑
2DBE-010-400-S04	●	1,5	R0,75	40	3	80	4	☑
2DBE-010-450-S04	●			45	3	80	4	☑
2DBE-010-500-S04	○			50	3	80	4	☑
2DBE-015-050-S04	●			-	5	60	4	☑
2DBE-015-080-S04	○			8	5	80	4	☑
2DBE-015-100-S04	●			10	5	80	4	☑
2DBE-015-120-S04	○	12	5	80	4	☑		
2DBE-015-150-S04	●	1,5	R0,75	15	5	80	4	☑
2DBE-015-150-S04-L60	●			15	5	60	4	☑
2DBE-015-180-S04	○			18	5	80	4	☑
2DBE-015-200-S04	●			20	5	80	4	☑
2DBE-015-250-S04	●			25	5	80	4	☑
2DBE-015-300-S04	●			30	5	80	4	☑
2DBE-015-350-S04	○	35	5	80	4	☑		
2DBE-015-400-S04	●	40	5	80	4	☑		
2DBE-020-060-S04	○	2	R1	-	6	60	4	☑
2DBE-020-100-S04	●			10	6	80	4	☑
2DBE-020-150-S04	●			15	6	80	4	☑
2DBE-020-200-S04	●			20	6	80	4	☑
2DBE-020-200-S04-L60	●			20	6	60	4	☑
2DBE-020-250-S04	●			25	6	80	4	☑
2DBE-020-300-S04	●	30	6	80	4	☑		
2DBE-020-350-S04	○	35	6	80	4	☑		
2DBE-020-400-S04	●	40	6	100	4	☑		
2DBE-020-450-S04	●	45	6	100	4	☑		
2DBE-020-500-S04	●	50	6	100	4	☑		

Objednací číslo	Skład	D (mm)	R (mm)	L2 (mm)	L1 (mm)	L (mm)	d h5 (mm)	Standardní položka		
2DBE-020-600-S04	○	2	R1	60	6	100	4	☑		
2DBE-020-700-S04	○			70	6	100	4	☑		
2DBE-030-150-100	●	3	R1,5	15	8	100	3	☑		
2DBE-030-080-S04	○			-	8	60	4	☑		
2DBE-030-150-S04-L60	●			15	8	60	4	☑		
2DBE-030-150-S04	○			15	8	100	4	☑		
2DBE-030-150-S06	●			15	3,5	60	6	☑		
2DBE-030-200-S04-L60	●			20	8	60	4	☑		
2DBE-030-200-S04	●			20	8	100	4	☑		
2DBE-030-250-S04	●			25	8	100	4	☑		
2DBE-030-300-S04-L60	●			30	8	60	4	☑		
2DBE-030-300-S04	●			30	8	100	4	☑		
2DBE-030-300-S06	●			30	3,5	60	6	☑		
2DBE-030-350-S04	●			35	8	100	4	☑		
2DBE-030-400-S04	●	3	R1,5	40	8	100	4	☑		
2DBE-030-500-S04	●			50	8	100	4	☑		
2DBE-030-600-S04	○			60	8	100	4	☑		
2DBE-030-700-S04	○			70	8	100	4	☑		
2DBE-040-040-060	○			-	4	60	4	☑		
2DBE-040-160-060	○			-	16	60	4	☑		
2DBE-040-200-S06	●	4	R2	20	5	60	6	☑		
2DBE-040-250-060-5	●			25	5	60	4	☑		
2DBE-040-250-S06	●			25	5	60	6	☑		
2DBE-040-300-S06	●			30	5	60	6	☑		
2DBE-040-160-080	●			-	16	80	4	☑		
2DBE-040-300-080	●			30	16	80	4	☑		
2DBE-040-160-100	●			-	16	100	4	☑		
2DBE-040-400-100	●			40	16	100	4	☑		
2DBE-040-400-100-5	●			40	5	100	4	☑		
2DBE-040-160-130	○			-	16	130	4	☑		
2DBE-040-400-130	○			40	16	130	4	☑		
2DBE-040-160-150	○			-	16	150	4	☑		
2DBE-040-500-150	○			50	16	150	4	☑		
2DBE-050-160-110	○			5	R2,5	-	16	110	5	☑
2DBE-050-400-110	●	40	16			110	5	☑		
2DBE-050-200-S06	●	20	16			110	6	☑		
2DBE-050-400-S06	●	40	16			110	6	☑		
2DBE-050-500-S06	●	50	16			110	6	☑		
2DBE-050-600-S06	○	60	16			110	6	☑		
2DBE-060-250-080	●	6	R3	25	16	80	6	☑		
2DBE-060-300-060	●			30	16	60	6	☑		
2DBE-060-300-080	●			30	16	80	6	☑		
2DBE-060-250-110	●			25	16	110	6	☑		
2DBE-060-400-110	●			40	16	110	6	☑		
2DBE-060-600-110	●			60	16	110	6	☑		
2DBE-060-300-150	●			30	16	150	6	☑		
2DBE-060-500-150	○			50	16	150	6	☑		
2DBE-080-300-080	●			8	R4	30	20	80	8	☑
2DBE-080-300-110	●					30	20	110	8	☑
2DBE-080-400-110	○	40	20			110	8	☑		
2DBE-080-400-200	○	40	20			200	8	☑		
2DBE-080-450-090	●	45	20			90	8	☑		

Objednací číslo	Skład	D (mm)	R (mm)	L2 (mm)	L1 (mm)	L (mm)	d h5 (mm)	Standardní položka
2DBE-080-450-110	●	8	R4	45	20	110	8	☑
2DBE-080-500-150	●			50	20	150	8	☑
2DBE-100-400-080	●	10	R5	40	22	80	10	☑
2DBE-100-400-110	●			40	22	110	10	☑
2DBE-100-500-110	○			50	22	110	10	☑
2DBE-100-600-160	●			60	22	160	10	☑
2DBE-100-500-200	○			50	22	200	10	☑
2DBE-120-500-110	●			12	R6	50	25	110
2DBE-120-500-160	○	50	25			160	12	☑
2DBE-120-600-200	○	60	25			200	12	☑

Celkovou délku (L) i délku vyložení (L2) je možno upravit podle Vašeho požadavku. Prosím kontaktujte nás.

3DBE 3-břité KULOVÉ frézy pro žebrování a s diamantovým povlakem pro obrábění grafitu, karbonu, vyztužených plastů a ZrO₂

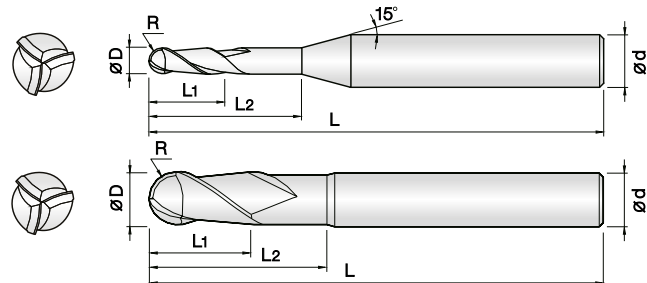

- Určeno pro grafit, karbon, vyztužené plasty a ZrO₂
- Vysoká odolnost proti opotřebení díky CVD diamantovému povlaku
- Široký sortiment rádiusů a vyložení pro optimální výběr nástroje

- - skladová položka
- - dodání obvykle 2-7 pracovních dnů

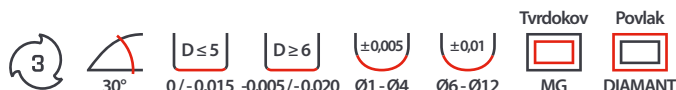

NOVINKA

Objednací číslo	Sklad	D (mm)	R (mm)	L2 (mm)	L1 (mm)	L (mm)	d h5 (mm)	Standardní položka		
3DBE-010-030-S04	○	1	R0,5	-	3	60	4	☑		
3DBE-010-050-S04	○			5	3	60	4	☑		
3DBE-010-100-S04	●			10	3	60	4	☑		
3DBE-010-150-S04	●			15	3	60	4	☑		
3DBE-010-200-S04	●			20	3	60	4	☑		
3DBE-010-250-S04	○			25	3	80	4	☑		
3DBE-010-300-S04	●			30	3	80	4	☑		
3DBE-010-350-S04	○			35	3	80	4	☑		
3DBE-010-400-S04	●			40	3	80	4	☑		
3DBE-010-450-S04	○			45	3	80	4	☑		
3DBE-010-500-S04	○			50	3	80	4	☑		
3DBE-015-050-S04	○			1,5	R0,75	-	5	60	4	☑
3DBE-015-100-S04	○					10	5	80	4	☑
3DBE-015-150-S04	●	15	5			80	4	☑		
3DBE-015-200-S04	○	20	5			80	4	☑		
3DBE-015-250-S04	○	25	8			80	4	☑		
3DBE-015-300-S04	○	30	8			80	4	☑		
3DBE-015-350-S04	○	35	8			80	4	☑		
3DBE-015-400-S04	○	40	8			80	4	☑		
3DBE-015-450-S04	○	45	8			80	4	☑		
3DBE-015-500-S04	○	50	8			80	4	☑		
3DBE-020-060-S04	○	2	R1	-	6	60	4	☑		
3DBE-020-100-S04	○			10	6	80	4	☑		
3DBE-020-150-S04	●			15	6	80	4	☑		
3DBE-020-200-S04	●			20	6	80	4	☑		
3DBE-020-250-S04	○			25	6	80	4	☑		
3DBE-020-300-S04	○			30	6	80	4	☑		
3DBE-020-350-S04	○			35	6	80	4	☑		
3DBE-020-400-S04	○			40	6	80	4	☑		
3DBE-020-500-S04	○			50	6	100	4	☑		
3DBE-020-600-S04	○			60	6	100	4	☑		
3DBE-020-700-S04	○	70	6	100	4	☑				
3DBE-030-150-100	○	3	R1,5	15	8	100	3	☑		
3DBE-030-080-S04	○			-	8	60	4	☑		
3DBE-030-150-S04	○			15	8	100	4	☑		
3DBE-030-200-S04	●			20	8	100	4	☑		
3DBE-030-300-S04	●			30	8	100	4	☑		
3DBE-030-400-S04	○			40	8	100	4	☑		

Objednací číslo	Sklad	D (mm)	R (mm)	L2 (mm)	L1 (mm)	L (mm)	d h5 (mm)	Standardní položka
3DBE-030-500-S04	○	3	R1,5	50	8	100	4	☑
3DBE-040-160-080	○	4	R2	-	16	80	4	☑
3DBE-040-300-080	○			30	16	80	4	☑
3DBE-040-160-100	○			-	16	100	4	☑
3DBE-040-400-100	○			40	16	100	4	☑
3DBE-040-160-130	○			-	16	130	4	☑
3DBE-040-400-130	○			40	16	130	4	☑
3DBE-050-160-110	○			5	R2,5	-	16	110
3DBE-050-400-110	○	40	16			110	5	☑
3DBE-060-250-110	○	6	R3	25	16	110	6	☑
3DBE-060-400-110	●			40	16	110	6	☑
3DBE-060-300-150	○			30	16	150	6	☑
3DBE-060-500-150	○			50	16	150	6	☑
3DBE-060-500-180	○	8	R4	50	16	180	6	☑
3DBE-080-400-110	○			40	20	110	8	☑
3DBE-080-500-150	○	10	R5	50	20	150	8	☑
3DBE-100-400-110	○			40	22	110	10	☑
3DBE-100-600-160	○			60	22	160	10	☑
3DBE-120-500-110	○	12	R6	50	25	110	12	☑
3DBE-120-500-160	○			50	25	160	12	☑
3DBE-120-600-200	○			60	25	200	12	☑

Celkovou délkou (L) i délkou vyložení (L2) je možno upravit podle Vašeho požadavku. Prosím kontaktujte nás.

▶ 4DBE 4-břité KULOVÉ frézy pro žebrování a s diamantovým povlakem pro obrábění grafitu, karbonu, vyztužených plastů a ZrO₂

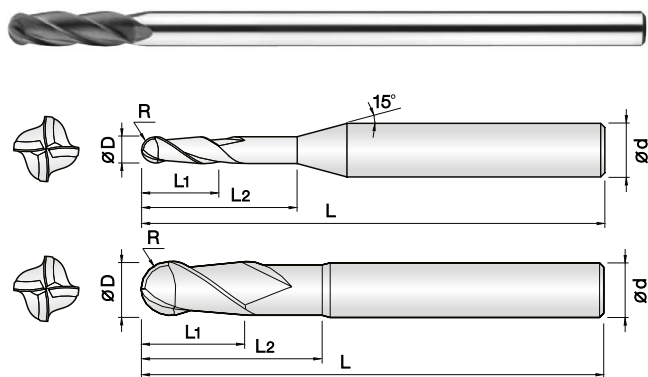

- ▶ Určeno pro grafit, karbon, vyztužené plasty a ZrO₂
- ▶ Vysoká odolnost proti opotřebení díky CVD diamantovému povlaku
- ▶ Široký sortiment rádiusů a vyložení pro optimální výběr nástroje

- - skladová položka
 - - dodání obvykle
- 2-7 pracovních dnů

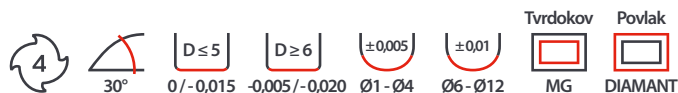

NOVINKA

Objednací číslo	Sklad	D (mm)	R (mm)	L2 (mm)	L1 (mm)	L (mm)	d h5 (mm)	Standardní položka		
4DBE-010-030-S04	○	1	R0,5	-	3	60	4	☑		
4DBE-010-050-S04	○			5	3	60	4	☑		
4DBE-010-100-S04	●			10	3	60	4	☑		
4DBE-010-150-S04	●			15	3	60	4	☑		
4DBE-010-200-S04	●			20	3	60	4	☑		
4DBE-010-250-S04	●			25	3	60	4	☑		
4DBE-010-300-S04	○			30	4,5	80	4	☑		
4DBE-010-350-S04	○			35	4,5	80	4	☑		
4DBE-010-400-S04	○			40	4,5	80	4	☑		
4DBE-010-450-S04	○			45	4,5	80	4	☑		
4DBE-010-500-S04	○			50	4,5	80	4	☑		
4DBE-015-045-S04	○			1,5	R0,75	-	4,5	60	4	☑
4DBE-015-100-S04	○					10	4,5	60	4	☑
4DBE-015-150-S04	○					15	4,5	60	4	☑
4DBE-015-200-S04	○	20	4,5			60	4	☑		
4DBE-015-250-S04	○	25	4,5			60	4	☑		
4DBE-015-300-S04	○	30	4,5			80	4	☑		
4DBE-015-350-S04	○	35	4,5			80	4	☑		
4DBE-015-400-S04	○	40	4,5			80	4	☑		
4DBE-015-450-S04	○	45	4,5			80	4	☑		
4DBE-015-500-S04	○	50	4,5			80	4	☑		
4DBE-020-060-S04	○	2	R1	-	6	60	4	☑		
4DBE-020-100-S04	○			10	6	80	4	☑		
4DBE-020-200-S04	●			20	6	80	4	☑		
4DBE-020-300-S04	●			30	6	80	4	☑		
4DBE-020-400-S04	○			40	6	80	4	☑		
4DBE-020-500-S04	○			50	6	100	4	☑		
4DBE-020-600-S04	○			60	6	100	4	☑		
4DBE-020-700-S04	○	70	6	100	4	☑				
4DBE-030-080-S04	○	3	R1,5	-	8	60	4	☑		
4DBE-030-150-S04	○			15	8	100	4	☑		
4DBE-030-200-S04	○			20	8	100	4	☑		
4DBE-030-300-S04	○			30	8	100	4	☑		
4DBE-030-400-S04	●			40	8	100	4	☑		
4DBE-030-500-S04	○			50	8	100	4	☑		
4DBE-030-600-S04	○			60	8	100	4	☑		
4DBE-030-700-S04	○	70	8	100	4	☑				
4DBE-040-160-060	○	4	R2	-	16	60	4	☑		

Objednací číslo	Sklad	D (mm)	R (mm)	L2 (mm)	L1 (mm)	L (mm)	d h5 (mm)	Standardní položka
4DBE-040-250-060	○	4	R2	25	16	60	4	☑
4DBE-040-160-080	○			-	16	80	4	☑
4DBE-040-160-100	○			-	16	100	4	☑
4DBE-040-160-130	○			-	16	130	4	☑
4DBE-040-400-100	○			40	16	100	4	☑
4DBE-060-250-080	○			6	R3	25	16	80
4DBE-060-300-080	○	30	16			80	6	☑
4DBE-060-250-110	○	25	16			110	6	☑
4DBE-060-300-150	○	30	16			150	6	☑
4DBE-060-600-110	●	60	16			110	6	☑
4DBE-080-300-080	○	8	R4			30	20	80
4DBE-080-300-110	○			30	20	110	8	☑
4DBE-080-350-150	○			35	20	150	8	☑
4DBE-080-400-200	○			40	20	200	8	☑
4DBE-100-350-080	○	10	R5	35	22	80	10	☑
4DBE-100-350-110	○			35	22	110	10	☑
4DBE-100-400-160	○			40	22	160	10	☑
4DBE-100-500-200	○			50	22	200	10	☑
4DBE-120-500-110	○	12	R6	50	25	110	12	☑
4DBE-120-500-160	○			50	25	160	12	☑
4DBE-120-600-200	○			60	25	200	12	☑

Celkovou délku (L) i délku vyložení (L2) je možno upravit podle Vašeho požadavku. Prosím kontaktujte nás.

▶ 3TBD

3-břité KULOVÉ frézy s kuželovým odlehčením pro žebrování a s diamantovým povlakem pro obrábění grafitu, karbonu, vyztužených plastů a ZrO₂

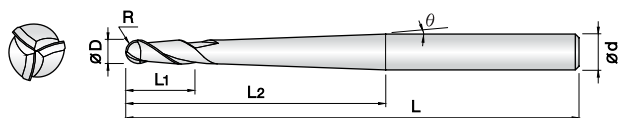

- ▶ Určeno pro grafit, karbon, vyztužené plasty a ZrO₂
- ▶ Vysoká odolnost proti opotřebení díky CVD diamantovému povlaku
- ▶ Vysoká tuhost a stabilita při dlouhých délkách díky kuželovému odlehčení

- - skladová položka
- - dodání obvykle 2-7 pracovních dnů

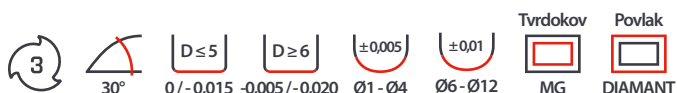

NOVINKA

Objednací číslo	Sklad	D (mm)	R (mm)	Úhel	L1 (mm)	L2 (mm)	L (mm)	d h5 (mm)	Standardní položka		
3TBD-010-003-300	○	1	R0,5	0°30	3	30	100	4	<input checked="" type="checkbox"/>		
3TBD-010-003-400	●			0°30	3	40	100	4	<input checked="" type="checkbox"/>		
3TBD-010-003-500	○			0°30	3	50	100	4	<input checked="" type="checkbox"/>		
3TBD-010-010-300	○			1°	3	30	100	4	<input checked="" type="checkbox"/>		
3TBD-010-010-400	●			1°	3	40	100	4	<input checked="" type="checkbox"/>		
3TBD-010-010-500	●			1°	3	50	100	4	<input checked="" type="checkbox"/>		
3TBD-010-010-600	●			1°	3	60	100	4	<input checked="" type="checkbox"/>		
3TBD-015-003-300	○			1,5	R0,75	0°30	4	30	100	4	<input checked="" type="checkbox"/>
3TBD-015-003-400	●					0°30	4	40	100	4	<input checked="" type="checkbox"/>
3TBD-015-003-500	○	0°30	4			50	100	4	<input checked="" type="checkbox"/>		
3TBD-015-010-400	○	1°	4			40	100	4	<input checked="" type="checkbox"/>		
3TBD-015-010-500	●	1°	4			50	100	4	<input checked="" type="checkbox"/>		
3TBD-015-010-600	○	1°	4			60	100	4	<input checked="" type="checkbox"/>		
3TBD-020-003-400	○	2	R1,0	0°30	5	40	130	4	<input checked="" type="checkbox"/>		
3TBD-020-003-500	●			0°30	5	50	130	4	<input checked="" type="checkbox"/>		
3TBD-020-003-600	○			0°30	5	60	130	4	<input checked="" type="checkbox"/>		
3TBD-020-010-500	○			1°	5	50	130	4	<input checked="" type="checkbox"/>		
3TBD-020-010-600	●			1°	5	60	130	4	<input checked="" type="checkbox"/>		
3TBD-020-010-700	●			1°	5	70	130	4	<input checked="" type="checkbox"/>		
3TBD-030-003-600	○	3	R1,5	0°30	6	60	150	6	<input checked="" type="checkbox"/>		
3TBD-030-003-800	●			0°30	6	80	150	6	<input checked="" type="checkbox"/>		
3TBD-030-010-700	●			1°	6	70	150	6	<input checked="" type="checkbox"/>		
3TBD-030-010-900	●			1°	6	90	150	6	<input checked="" type="checkbox"/>		
3TBD-040-003-800	●	4	R2	0°30	8	80	150	6	<input checked="" type="checkbox"/>		
3TBD-040-003-1000	○			0°30	8	100	150	6	<input checked="" type="checkbox"/>		
3TBD-040-010-1000	○			1°	8	100	150	6	<input checked="" type="checkbox"/>		

KULOVÉ

TOROIDNÍ

OSTŘÉ

HRUBOVACÍ

▶ 2DCR 2-břité TOROIDNÍ frézy pro žebrování a s diamantovým povlakem pro obrábění grafitu, karbonu, vyztužených plastů a ZrO₂

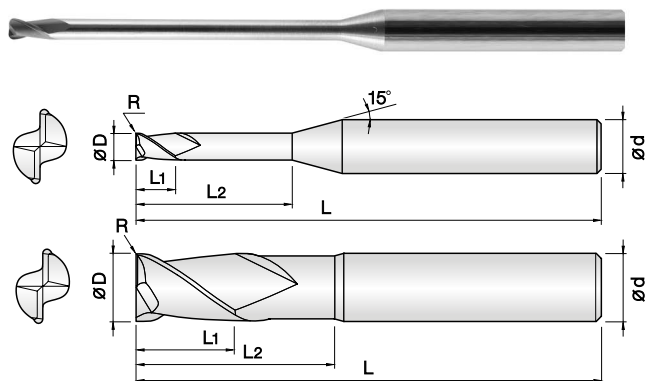

- ▶ **Určeno pro grafit, karbon, vyztužené plasty a ZrO₂**
- ▶ Vysoká odolnost proti opotřebení díky CVD diamantovému povlaku
- ▶ Široký sortiment rádiusů a vyložení pro optimální výběr nástroje

- - skladová položka
 - - dodání obvykle
- 2-7 pracovních dnů

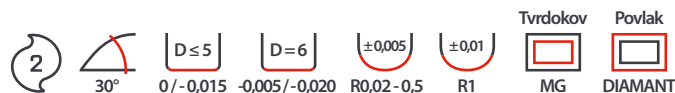

NOVINKA

Objednací číslo	Sklad	D (mm)	R (mm)	L2 (mm)	L1 (mm)	L (mm)	d h5 (mm)	Standardní položka
2DCR-002-0002-015	○	0,2	R0,02	1,5	0,5	60	4	☑
2DCR-003-0002-015	○	0,3	R0,02	1,5	0,6	60	4	☑
2DCR-003-0002-030	○			3	0,6	60	4	☑
2DCR-003-0002-045	○			4,5	0,6	60	4	☑
2DCR-003-0002-060	○			6	0,6	60	4	☑
2DCR-004-0002-020	○			0,4	R0,02	2	0,8	60
2DCR-004-0002-040	○	4	0,8			60	4	☑
2DCR-004-0002-060	○	6	0,8			60	4	☑
2DCR-004-0002-080	○	8	0,8			60	4	☑
2DCR-005-0005-010	○	0,5	R0,05			-	1	60
2DCR-005-0005-025	○			2,5	1	60	4	☑
2DCR-005-0005-035	○			3,5	1	60	4	☑
2DCR-005-0005-050	●			5	1	60	4	☑
2DCR-005-0005-075	●			7,5	1	60	4	☑
2DCR-005-0005-100	○	0,6	R0,05	10	1	60	4	☑
2DCR-006-0005-012	○			-	1,2	60	4	☑
2DCR-006-0005-030	○			3	1,2	60	4	☑
2DCR-006-0005-060	●			6	1,2	60	4	☑
2DCR-006-0005-090	○			9	1,2	60	4	☑
2DCR-006-0005-120	○	0,8	R0,05	12	1,2	60	4	☑
2DCR-008-0005-016	○			-	1,6	60	4	☑
2DCR-008-0005-040	○			4	1,6	60	4	☑
2DCR-008-0005-080	○			8	1,6	60	4	☑
2DCR-008-0005-100	○			10	1,6	60	4	☑
2DCR-008-0005-160	○	16	1,6	60	4	☑		
2DCR-010-0005-020	○	1	R0,05	-	2	60	4	☑
2DCR-010-0005-050	○			5	2	60	4	☑
2DCR-010-0005-100	●			10	2	60	4	☑
2DCR-010-0005-150	●			15	2	60	4	☑
2DCR-010-0005-200	○			20	2	60	4	☑
2DCR-010-001-020	○		R0,1	-	2	60	4	☑
2DCR-010-001-050	○			5	2	60	4	☑
2DCR-010-001-100	●			10	2	60	4	☑
2DCR-010-001-150	●			15	2	60	4	☑
2DCR-010-001-200	●			20	2	60	4	☑
2DCR-010-002-020	○	R0,2	-	2	60	4	☑	
2DCR-010-002-050	●		5	2	60	4	☑	
2DCR-010-002-100	●		10	2	60	4	☑	
2DCR-010-002-150	●		15	2	60	4	☑	
2DCR-010-002-200	○		20	2	60	4	☑	
2DCR-010-002-020	○		-	2	60	4	☑	
2DCR-010-002-050	●		5	2	60	4	☑	
2DCR-010-002-100	●		10	2	60	4	☑	

Objednací číslo	Sklad	D (mm)	R (mm)	L2 (mm)	L1 (mm)	L (mm)	d h5 (mm)	Standardní položka
2DCR-010-002-150	●	1	R0,2	15	2	60	4	☑
2DCR-010-002-200	●			20	2	60	4	☑
2DCR-015-0005-030	○	1,5	R0,05	-	3	60	4	☑
2DCR-015-0005-050	○			5	3	60	4	☑
2DCR-015-0005-100	●			10	3	60	4	☑
2DCR-015-0005-150	●			15	3	60	4	☑
2DCR-015-0005-200	○			20	3	60	4	☑
2DCR-015-001-030	○		R0,1	-	3	60	4	☑
2DCR-015-001-050	○			5	3	60	4	☑
2DCR-015-001-100	○			10	3	60	4	☑
2DCR-015-001-150	○			15	3	60	4	☑
2DCR-015-001-200	○			20	3	60	4	☑
2DCR-015-0015-030	○	1,5	R0,15	-	3	60	4	☑
2DCR-015-0015-050	○			5	3	60	4	☑
2DCR-015-0015-100	●			10	3	60	4	☑
2DCR-015-0015-150	●			15	3	60	4	☑
2DCR-015-0015-200	○			20	3	60	4	☑
2DCR-015-002-030	○		R0,2	-	3	60	4	☑
2DCR-015-002-050	○			5	3	60	4	☑
2DCR-015-002-100	●			10	3	60	4	☑
2DCR-015-002-150	○			15	3	60	4	☑
2DCR-015-002-200	●			20	3	60	4	☑
2DCR-015-003-030	○	R0,3		-	3	60	4	☑
2DCR-015-003-050	○			5	3	60	4	☑
2DCR-015-003-100	○			10	3	60	4	☑
2DCR-015-003-150	○		15	3	60	4	☑	
2DCR-015-003-200	○		20	3	60	4	☑	
2DCR-020-0005-035	○	2	R0,05	-	3,5	60	4	☑
2DCR-020-0005-060	○			6	3,5	60	4	☑
2DCR-020-0005-120	○			12	3,5	60	4	☑
2DCR-020-0005-180	●			18	3,5	60	4	☑
2DCR-020-0005-250	●			25	3,5	60	4	☑
2DCR-020-0005-300	○		30	3,5	60	4	☑	
2DCR-020-002-035	○		R0,2	-	3,5	60	4	☑
2DCR-020-002-060	○			6	3,5	60	4	☑
2DCR-020-002-120	●			12	3,5	60	4	☑
2DCR-020-002-180	●			18	3,5	60	4	☑
2DCR-020-002-200	●	20		3,5	60	4	☑	

Objednací číslo	Sklad	D (mm)	R (mm)	L2 (mm)	L1 (mm)	L (mm)	d h5 (mm)	Standardní položka		
2DCR-020-002-250	●	2	R0,2	25	3,5	60	4	☑		
2DCR-020-002-300	●			30	3,5	60	4	☑		
2DCR-020-003-035	○			R0,3	-	3,5	60	4	☑	
2DCR-020-003-060	○				6	3,5	60	4	☑	
2DCR-020-003-120	○		12		3,5	60	4	☑		
2DCR-020-003-180	●		18		3,5	60	4	☑		
2DCR-020-003-250	●		25		3,5	60	4	☑		
2DCR-020-003-300	●		30		3,5	60	4	☑		
2DCR-020-005-035	○		R0,5		-	3,5	60	4	☑	
2DCR-020-005-060	○				6	3,5	60	4	☑	
2DCR-020-005-120	○			12	3,5	60	4	☑		
2DCR-020-005-180	●			18	3,5	60	4	☑		
2DCR-020-005-250	●			25	3,5	60	4	☑		
2DCR-020-005-300	●			30	3,5	60	4	☑		
2DCR-030-0005-040	○			3	R0,05	-	4	80	4	☑
2DCR-030-0005-100	○					10	4	80	4	☑
2DCR-030-0005-200	●		20			4	80	4	☑	
2DCR-030-0005-300	○		30			4	80	4	☑	
2DCR-030-0005-400	○		40		4	80	4	☑		
2DCR-030-002-040	○		R0,2		-	4	80	4	☑	
2DCR-030-002-100	○	10			4	80	4	☑		
2DCR-030-002-200	●	20			4	80	4	☑		
2DCR-030-002-300	●	30			4	80	4	☑		
2DCR-030-002-400	●	40	4		80	4	☑			
2DCR-030-003-040	○	R0,3	-		4	80	4	☑		
2DCR-030-003-100	●		10		4	80	4	☑		
2DCR-030-003-200-L60	●		20	4	60	4	☑			
2DCR-030-003-200	●		20	4	80	4	☑			
2DCR-030-003-300	●		30	4	80	4	☑			
2DCR-030-003-300-S06	●		30	3,5	60	6	☑			
2DCR-030-003-400	●		40	4	80	4	☑			
2DCR-030-005-040	○		R0,5	-	4	80	4	☑		
2DCR-030-005-100	○	10		4	80	4	☑			
2DCR-030-005-200	●	20		4	80	4	☑			
2DCR-030-005-300	●	30		4	80	4	☑			
2DCR-030-005-400	●	40		4	80	4	☑			
2DCR-030-010-040	○	R1		-	4	80	4	☑		
2DCR-030-010-100	○			10	4	80	4	☑		
2DCR-030-010-200	○			20	4	80	4	☑		
2DCR-030-010-300	○		30	4	80	4	☑			
2DCR-030-010-400	○	40	4	80	4	☑				
2DCR-040-0005-050	○	4	R0,05	-	5	80	4	☑		
2DCR-040-0005-150	○			15	5	80	4	☑		
2DCR-040-0005-250	○			25	5	80	4	☑		
2DCR-040-0005-400	○			40	5	80	4	☑		
2DCR-040-002-050	○		R0,2	-	5	80	4	☑		
2DCR-040-002-150	○			15	5	80	4	☑		
2DCR-040-002-250	●			25	5	80	4	☑		
2DCR-040-002-400	●			40	5	80	4	☑		
2DCR-040-005-050	○		R0,5	-	5	80	4	☑		
2DCR-040-005-150	●			15	5	80	4	☑		
2DCR-040-005-250-L60	●			25	5	60	4	☑		
2DCR-040-005-250	●			25	5	80	4	☑		

Objednací číslo	Sklad	D (mm)	R (mm)	L2 (mm)	L1 (mm)	L (mm)	d h5 (mm)	Standardní položka	
2DCR-040-005-250	●	4	R0,5	25	5	80	4	☑	
2DCR-040-005-250-S06	●			25	5	60	6	☑	
2DCR-040-005-400	●			40	5	80	4	☑	
2DCR-040-010-050	○			R1	-	5	80	4	☑
2DCR-040-010-150	○		15		5	80	4	☑	
2DCR-040-010-250	○		25		5	80	4	☑	
2DCR-040-010-400	○		40		5	80	4	☑	
2DCR-050-0005-060	○		5	R0,05	-	6	110	6	☑
2DCR-050-0005-150	○				15	6	110	6	☑
2DCR-050-0005-300	○				30	6	110	6	☑
2DCR-050-0005-500	○				50	6	110	6	☑
2DCR-050-002-060	○			R0,2	-	6	110	6	☑
2DCR-050-002-150	○				15	6	110	6	☑
2DCR-050-002-300	●				30	6	110	6	☑
2DCR-050-002-500	○				50	6	110	6	☑
2DCR-050-005-060	○			R0,5	-	6	110	6	☑
2DCR-050-005-150	○				15	6	110	6	☑
2DCR-050-005-300	●				30	6	110	6	☑
2DCR-050-005-500	●				50	6	110	6	☑
2DCR-060-0005-070	○		6	R0,05	-	7	110	6	☑
2DCR-060-0005-200	○	20			7	110	6	☑	
2DCR-060-0005-300	●	30			7	110	6	☑	
2DCR-060-0005-500	○	50			7	110	6	☑	
2DCR-060-002-070	○	R0,2		-	7	110	6	☑	
2DCR-060-002-200	○			20	7	110	6	☑	
2DCR-060-002-300	○			30	7	110	6	☑	
2DCR-060-002-500	●			50	7	110	6	☑	
2DCR-060-005-070	○	R0,5		-	7	110	6	☑	
2DCR-060-005-180-L60	●			18	7	60	6	☑	
2DCR-060-005-200	○			20	7	110	6	☑	
2DCR-060-005-300-L60	●			30	7	60	6	☑	
2DCR-060-005-300	●		30	7	110	6	☑		
2DCR-060-005-500	●		50	7	110	6	☑		
2DCR-060-010-070	○		R1	-	7	110	6	☑	
2DCR-060-010-200	○			20	7	110	6	☑	
2DCR-060-010-300	○	30		7	110	6	☑		
2DCR-060-010-500	○	50		7	110	6	☑		

Celkovou délku (L) i délku vyložení (L2) je možno upravit podle Vašeho požadavku. Prosím kontaktujte nás.

▶ 4DCR 4-břité TOROIDNÍ frézy pro žebrování a s diamantovým povlakem pro obrábění grafitu, karbonu, vyztužených plastů a ZrO₂

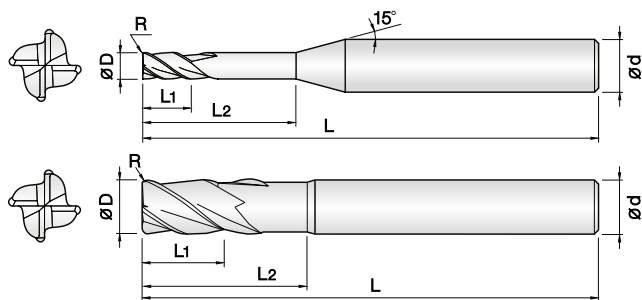

- ▶ Určeno pro grafit, karbon, vyztužené plasty a ZrO₂
- ▶ Vysoká odolnost proti opotřebení díky CVD diamantovému povlaku
- ▶ Široký sortiment rádiusů a vyložení pro optimální výběr nástroje

- - skladová položka
 - - dodání obvykle
- 2-7 pracovních dnů

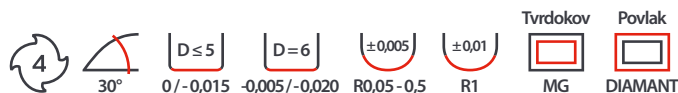

Objednací číslo	Sklad	D (mm)	R (mm)	L2 (mm)	L1 (mm)	L (mm)	d h5 (mm)	Standardní položka
4DCR-020-0005-035	○	2	R0,05	-	3,5	60	4	☑
4DCR-020-0005-060	○			6	3,5	60	4	☑
4DCR-020-0005-120	○			12	3,5	60	4	☑
4DCR-020-0005-180	○			18	3,5	60	4	☑
4DCR-020-0005-250	●			25	3,5	60	4	☑
4DCR-020-0005-300	○			30	3,5	60	4	☑
4DCR-020-002-035	○		R0,2	-	3,5	60	4	☑
4DCR-020-002-060	○			6	3,5	60	4	☑
4DCR-020-002-120	○			12	3,5	60	4	☑
4DCR-020-002-180	○			18	3,5	60	4	☑
4DCR-020-002-250	●			25	3,5	60	4	☑
4DCR-020-002-300	●			30	3,5	60	4	☑
4DCR-020-003-035	○		R0,3	-	3,5	60	4	☑
4DCR-020-003-060	○			6	3,5	60	4	☑
4DCR-020-003-120	○			12	3,5	60	4	☑
4DCR-020-003-180	●			18	3,5	60	4	☑
4DCR-020-003-250	○			25	3,5	60	4	☑
4DCR-020-003-300	○			30	3,5	60	4	☑
4DCR-020-005-035	○		R0,5	-	3,5	60	4	☑
4DCR-020-005-060	○			6	3,5	60	4	☑
4DCR-020-005-120	○			12	3,5	60	4	☑
4DCR-020-005-180	○			18	3,5	60	4	☑
4DCR-020-005-250	○			25	3,5	60	4	☑
4DCR-020-005-300	○			30	3,5	60	4	☑
4DCR-030-0005-040	○	3	R0,05	-	4	80	4	☑
4DCR-030-0005-100	○			10	4	80	4	☑
4DCR-030-0005-200	○			20	4	80	4	☑
4DCR-030-0005-300	○			30	4	80	4	☑
4DCR-030-0005-400	○			40	4	80	4	☑
4DCR-030-002-040	○			R0,2	-	4	80	4
4DCR-030-002-100	○		10		4	80	4	☑
4DCR-030-002-200	○		20		4	80	4	☑
4DCR-030-002-300	○		30		4	80	4	☑
4DCR-030-002-400	○		40		4	80	4	☑
4DCR-030-003-040	○		R0,3		-	4	80	4
4DCR-030-003-100	○			10	4	80	4	☑
4DCR-030-003-200	○			20	4	80	4	☑
4DCR-030-003-300	●			30	4	80	4	☑

Objednací číslo	Sklad	D (mm)	R (mm)	L2 (mm)	L1 (mm)	L (mm)	d h5 (mm)	Standardní položka		
4DCR-030-003-400	●	3	R0,3	40	4	80	4	☑		
4DCR-030-005-040	○		R0,5	-	4	80	4	☑		
4DCR-030-005-100	○			10	4	80	4	☑		
4DCR-030-005-200	●			20	4	80	4	☑		
4DCR-030-005-300	○			30	4	80	4	☑		
4DCR-030-005-400	○			40	4	80	4	☑		
4DCR-030-010-040	○			R1	-	4	80	4	☑	
4DCR-030-010-100	○		10		4	80	4	☑		
4DCR-030-010-200	○		20		4	80	4	☑		
4DCR-030-010-300	○		30		4	80	4	☑		
4DCR-030-010-400	○		40		4	80	4	☑		
4DCR-040-003-100	●		4		R0,3	20	6	100	4	☑
4DCR-040-005-100	●			R0,5	20	6	100	4	☑	
4DCR-040-010-100	○			R1	20	6	100	4	☑	
4DCR-060-003-110	●		6	R0,3	25	9	110	6	☑	
4DCR-060-005-110	●				R0,5	25	9	110	6	☑
4DCR-060-005-150	●					30	9	150	6	☑
4DCR-060-010-110	●			R1		25	9	110	6	☑
4DCR-060-010-150	○				30	9	150	6	☑	
4DCR-080-003-110	○				8	R0,3	30	12	110	8
4DCR-080-005-110	●		R0,5	30		12	110	8	☑	
4DCR-080-005-150	○			40		12	150	8	☑	
4DCR-080-010-080-60	●			R1		60	12	80	8	☑
4DCR-080-010-110	●		30			12	110	8	☑	
4DCR-080-010-150	●	40	12	150		8	☑			
4DCR-100-005-110	●	10	R0,5	35		15	110	10	☑	
4DCR-100-005-160	○			45		15	160	10	☑	
4DCR-100-010-110	●			R1	35	15	110	10	☑	
4DCR-100-010-160	●		45		15	160	10	☑		
4DCR-120-005-110	●		R0,5		40	18	110	12	☑	
4DCR-120-005-160	●			45	18	160	12	☑		
4DCR-120-010-110	○	R1		40	18	110	12	☑		
4DCR-120-010-160	○			45	18	160	12	☑		

Celkovou délku (L) i délku vyložení (L2) je možno upravit podle Vašeho požadavku. Prosím kontaktujte nás.

2DEM 2 a 3-břité OSTRÉ frézy s diamantovým povlakem pro obrábění grafitu, karbonu, vyztužených plastů a ZrO₂

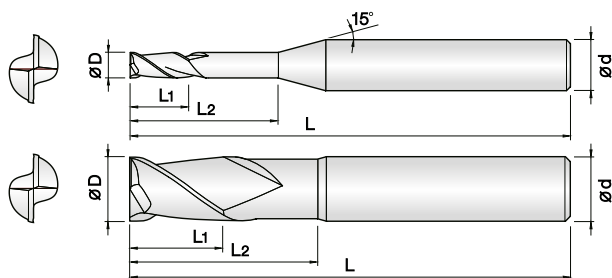

- Určeno pro grafit, karbon, vyztužené plasty a ZrO₂
- Vysoká odolnost proti opotřebení díky CVD diamantovému povlaku
- Široký sortiment pracovních délek a vyložení pro optimální výběr nástroje

- - skladová položka
- - dodání obvykle 2-7 pracovních dnů

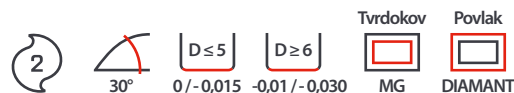

NOVINKA

Objednáací číslo	Sklad	D (mm)	L2 (mm)	L1 (mm)	L (mm)	d h5 (mm)	Standardní položka
2DEM-002-004-S04	○	0,2	-	0,4	45	4	☑
2DEM-003-006-S04	○		-	0,6	45	4	☑
2DEM-003-020-S04	○	0,3	2	0,6	45	4	☑
2DEM-003-040-S04	○		4	0,6	45	4	☑
2DEM-004-008-S04	○		-	0,8	45	4	☑
2DEM-004-020-S04	○	0,4	2	0,8	45	4	☑
2DEM-004-040-S04	○		4	0,8	45	4	☑
2DEM-005-010-S04	○		-	1	45	4	☑
2DEM-005-030-S04	○	0,5	3	1	45	4	☑
2DEM-005-050-S04	○		5	1	45	4	☑
2DEM-006-012-S04	○		-	1,2	45	4	☑
2DEM-006-030-S04	○	0,6	3	1,2	45	4	☑
2DEM-006-050-S04	○		5	1,2	45	4	☑
2DEM-007-015-S04	○		-	1,5	45	4	☑
2DEM-007-040-S04	○	0,7	4	1,5	45	4	☑
2DEM-007-060-S04	○		6	1,5	45	4	☑
2DEM-007-080-S04	○		8	1,5	45	4	☑
2DEM-008-020-S04	○	0,8	-	2	45	4	☑
2DEM-009-025-S04	○	0,9	-	2,5	45	4	☑
2DEM-010-032-S04	○		-	3,2	45	4	☑
2DEM-010-030-S04	○		-	3	60	4	☑
2DEM-010-050-S04	●		5	3	60	4	☑
2DEM-010-100-S04	●	1	10	3	60	4	☑
2DEM-010-150-S04	●		15	3	60	4	☑
2DEM-010-200-S04	○		20	3	60	4	☑
2DEM-010-250-S04	○		25	3	60	4	☑
2DEM-010-300-S04	○		30	3	60	4	☑
2DEM-015-060-S04	○		-	6	60	4	☑
2DEM-015-100-S04	○	1,5	10	6	60	4	☑
2DEM-015-150-S04	○		15	6	60	4	☑
2DEM-015-200-S04	○		20	6	60	4	☑
2DEM-015-250-S04	○		25	6	60	4	☑
2DEM-015-300-S04	○		30	6	60	4	☑
2DEM-020-060-S04	○		-	6	45	4	☑
2DEM-020-080-S04	○		-	8	80	4	☑
2DEM-020-120-S04	●	2	12	8	80	4	☑
2DEM-020-150-S04	●		15	8	80	4	☑
2DEM-020-200-S04	●		20	8	80	4	☑

Objednáací číslo	Sklad	D (mm)	L2 (mm)	L1 (mm)	L (mm)	d h5 (mm)	Standardní položka
2DEM-020-250-S04	○		25	8	80	4	☑
2DEM-020-300-S04	○		30	8	80	4	☑
2DEM-020-400-S04	○	2	40	8	80	4	☑
2DEM-020-450-S04	○		45	8	80	4	☑
2DEM-020-500-S04	○		50	8	80	4	☑
2DEM-030-090-S06	○		-	9	50	6	☑
2DEM-030-120-S04	○		-	12	80	4	☑
2DEM-030-200-S04	○		20	12	80	4	☑
2DEM-030-250-S04	○	3	25	12	80	4	☑
2DEM-030-300-S04	○		30	12	80	4	☑
2DEM-030-400-S04	○		40	12	80	4	☑
2DEM-030-500-S04	○		50	12	80	4	☑
2DEM-040-120-S06	○	4	-	12	50	6	☑
2DEM-040-160-080	○		-	16	80	4	☑
2DEM-050-150-S06	○	5	-	15	60	6	☑
2DEM-050-200-S06	○		-	20	110	6	☑
2DEM-060-180-S06	○		-	18	60	6	☑
2DEM-060-250-110	●	6	-	25	110	6	☑
2DEM-060-250-150	○		-	25	150	6	☑
2DEM-080-240-S08	○	8	-	24	70	8	☑
2DEM-080-400-150	○		40	25	150	8	☑
2DEM-100-250-S10	○	10	-	25	80	10	☑
2DEM-100-500-160	○		50	25	160	10	☑
2DEM-120-250-S12	○	12	-	25	80	12	☑
2DEM-120-600-160	○		60	25	160	12	☑

Celkovou délku (L) i délku vyložení (L2) je možno upravit podle Vašeho požadavku. Prosím kontaktujte nás.

KULOVÉ

TOROIDNÍ

OSTRÉ

HRUBOVACÍ

▶ 3DEM 2 a 3-břité OSTRÉ frézy s diamantovým povlakem pro obrábění grafitu, karbonu, vyztužených plastů a ZrO₂

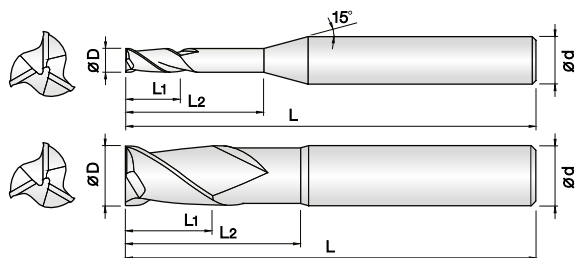

- ▶ **Určeno pro grafit, karbon, vyztužené plasty a ZrO₂**
- ▶ Vysoká odolnost proti opotřebení díky CVD diamantovému povlaku
- ▶ Široký sortiment pracovních délek a vyložení pro optimální výběr nástroje

- - skladová položka
- - dodání obvykle 2-7 pracovních dnů

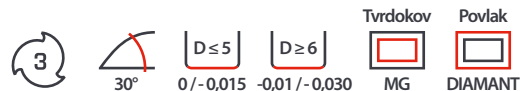

NOVINKA

Objednací číslo	Sklad	D (mm)	L2 (mm)	L1 (mm)	L (mm)	d h5 (mm)	Standardní položka
3DEM-010-030-S04	○	1	-	3	45	4	<input checked="" type="checkbox"/>
3DEM-010-050-S04	○		5	3	45	4	<input checked="" type="checkbox"/>
3DEM-010-100-S04	○		10	3	45	4	<input checked="" type="checkbox"/>
3DEM-010-150-S04	○		15	3	45	4	<input checked="" type="checkbox"/>
3DEM-015-060-S04	○	1,5	-	6	60	4	<input checked="" type="checkbox"/>
3DEM-015-100-S04	○		10	6	60	4	<input checked="" type="checkbox"/>
3DEM-015-150-S04	○		15	6	60	4	<input checked="" type="checkbox"/>
3DEM-015-200-S04	○		20	6	60	4	<input checked="" type="checkbox"/>
3DEM-020-060-S04	○	2	-	6	45	4	<input checked="" type="checkbox"/>
3DEM-020-100-S04	○		10	10	60	4	<input checked="" type="checkbox"/>
3DEM-020-150-S04	○		15	10	60	4	<input checked="" type="checkbox"/>
3DEM-020-200-S04	○		20	10	60	4	<input checked="" type="checkbox"/>
3DEM-020-250-S04	○		25	10	60	4	<input checked="" type="checkbox"/>
3DEM-030-090-S06	○	3	9	9	50	6	<input checked="" type="checkbox"/>
3DEM-030-150-S03	○		-	15	60	3	<input checked="" type="checkbox"/>
3DEM-030-150-S04	○		-	15	60	4	<input checked="" type="checkbox"/>
3DEM-030-200-S04	○		20	15	60	4	<input checked="" type="checkbox"/>
3DEM-030-250-S04	○		25	15	60	4	<input checked="" type="checkbox"/>
3DEM-040-120-S06	○	4	-	12	50	6	<input checked="" type="checkbox"/>
3DEM-040-200-080	●		-	20	80	6	<input checked="" type="checkbox"/>
3DEM-060-180-060	○	6	-	18	60	6	<input checked="" type="checkbox"/>
3DEM-060-250-110	○		-	25	110	6	<input checked="" type="checkbox"/>
3DEM-060-250-150	○		-	25	150	6	<input checked="" type="checkbox"/>
3DEM-080-240-070	●	8	-	24	70	8	<input checked="" type="checkbox"/>
3DEM-080-350-110	○		-	35	110	8	<input checked="" type="checkbox"/>
3DEM-080-350-150	○		-	35	150	8	<input checked="" type="checkbox"/>
3DEM-100-250-080	○	10	-	25	80	10	<input checked="" type="checkbox"/>
3DEM-100-400-110	○		-	40	110	10	<input checked="" type="checkbox"/>
3DEM-100-500-160	○		-	50	160	10	<input checked="" type="checkbox"/>
3DEM-120-250-080	○		-	25	80	12	<input checked="" type="checkbox"/>
3DEM-120-450-110	○	12	-	45	110	12	<input checked="" type="checkbox"/>
3DEM-120-550-160	○		-	55	160	12	<input checked="" type="checkbox"/>

KULOVÉ

TOROIDNÍ

OSTRÉ

HRUBOVACÍ

▶ 2DKU 2-břité OSTRÉ frézy s diamantovým povlakem pro HRUBOVACÍ frézování grafitu



- ▶ **Určeno pro hrubování grafitu**
- ▶ Vysoká rychlost odebrání materiálu
- ▶ Vysoká odolnost proti opotřebení díky CVD diamantovému povlaku

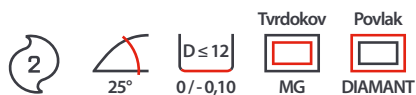
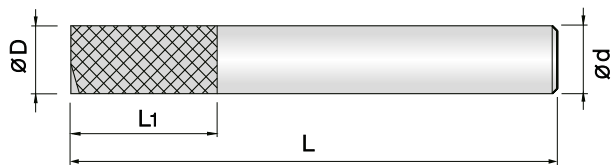

Objednací číslo	D (mm)	L1 (mm)	L (mm)	d h6 (mm)	Standardní položka
2DKU-040-110-060	4	11	60	4	<input checked="" type="checkbox"/>
2DKU-060-170-078	6	17	78	6	<input checked="" type="checkbox"/>
2DKU-080-230-078	8	23	78	8	<input checked="" type="checkbox"/>
2DKU-100-290-078	10	29	78	10	<input checked="" type="checkbox"/>
2DKU-120-360-089	12	36	89	12	<input checked="" type="checkbox"/>

KULOVÉ

TOROIDNÍ

OSTRÉ

HRUBOVACÍ