

TOROIDNÍ série V

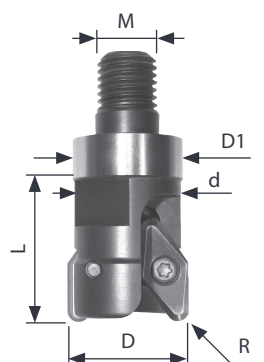

0°



Uložení destičky ve frézovací hlavě

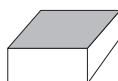

PLOCHY

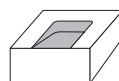

ZANOŘOVÁNÍ

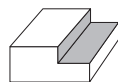

BOKY

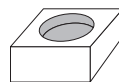

KRUHOVÉ ZANOŘOVÁNÍ

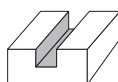

DRÁŽKY

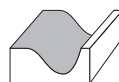

TVARY

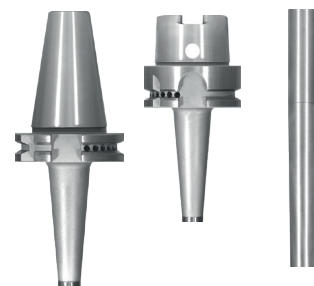

Nabídku na UPÍNAČE
Vám zašleme na vyžádání.

Objednací číslo	Sklad	D (mm)	R (mm)	Počet zubů	M (mm)		L (mm)	D1 (mm)	d (mm)				Standardní položka
1-12-881	○	12	R1	1	M6	VDGT 11T210	33	6,5	10	✓	993 02	T7	☑
1-12-880	○			1	M8		33	8,5	13,5	✓	993 02	T7	☑
2-15-879	○	15		2	M8		36	8,5	13,5	✓	993 02	T7	☑
2-16-815	○	16		2	M8		36	8,5	13,5	✓	993 02	T7	☑
2-16-815-M10	○			2	M10		36	10,5	15,4	✓	993 02	T7	☑
2-20-878	○	20		2	M10		36	10,5	18	✓	993 02	T7	☑
3-25-877	○	25		3	M12		41	12,5	21	✓	993 02	T7	☑
4-32-876	○	32		4	M16		45	17	29	✓	993 02	T7	☑
5-42-875	○	42		5	M16		45	17	34	✓	993 02	T7	☑
2-32-874	○	32		R3	2		M16	VCGX 220530	48	17	29	✓	993 06
3-42-873	○	42	3		M16	48	17		34	✓	993 06	T20	☑
3-42-873-37	○	42	3		M16	48	17		37	✓	993 06	T20	☑

○ dodání obvykle do 1 týdne

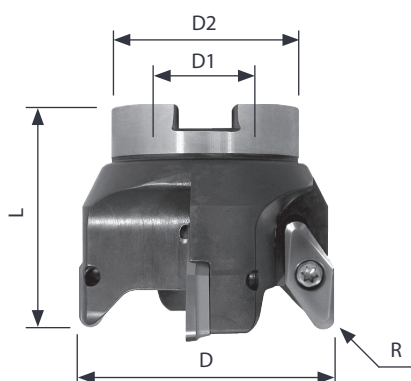

0°



Uložení destičky ve frézovací hlavě

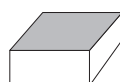

PLOCHY

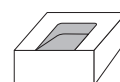

ZANOŘOVÁNÍ

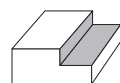

BOKY

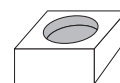

KRUHOVÉ ZANOŘOVÁNÍ

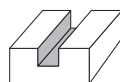

DRÁŽKY



TVARY

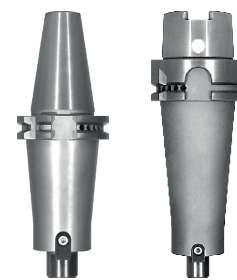

Nabídku na UPÍNAČE
Vám zašleme na vyžádání.

Objednací číslo	Sklad	D (mm)	R (mm)	Počet zubů	D1 (mm)		D2 (mm)	L (mm)				Standardní položka
3-42-872	○	42	R3	3	16	VCGX 220530	35	57	✓	993 06	T20	☑
3-50-871	○	50		3	22		40	57	✓	993 06	T20	☑
3-52-871	○	52		3	22		40	57	✓	993 06	T20	☑
4-66-870	○	66		4	27		48	57	✓	993 06	T20	☑
4-80-869	○	80		4	27		60	57	✓	993 06	T20	☑
5-100-868	○	100		5	32		70	55	-	993 06	T20	☑
6-125-867	○	125		6	40		90	55	-	993 06	T20	☑

○ dodání obvykle do 1 týdne

► TOROIDNÍ série V

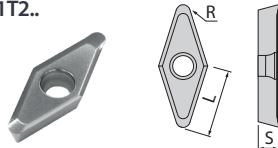
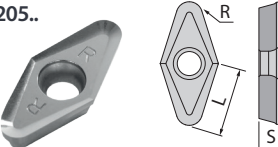
Tvar	Počet řezných hran	R (mm)	L (mm)	S (mm)	Typ řezné hrany	Tolerance destičky	Objednací číslo	Sklad	HLINÍK	GRAFIT
									SORTA (Tvrdokov + Povlak)	
									Bez povlaku	CVD
									K10 (leštěné)	DIA
VDGT 11T2.. 	2	R1,0	9	2,8	Ostrá řezná hrana	G	VDGT 11T210-ALU K10	●	<input checked="" type="checkbox"/>	
							VDGT 11T210-DIA	●		<input checked="" type="checkbox"/>
VCGX 2205.. 	2	R3,0	16	5,56	Ostrá řezná hrana	G	VCGX 220530-ALU K10	●	<input checked="" type="checkbox"/>	
							VCGX 220530-DIA	□		<input checked="" type="checkbox"/>

● skladová položka

□ termín dodání bude upřesněn