

REGO-FIX▲

NOVÉ
NIŽŠÍ
CENY

Extrémní upínací
síla ≤ 1100 Nm

REGO-FIX▲



Pro stopky
 $\varnothing 0,2 - 25,4$ mm

△ REGO-FIX® HFO
Swiss Made
powRgrip® pat. pend.
TC40/PG25x080 H
4240.72540.100

powRgrip®

Precizní upínání.

**I tehdy, když
chybí zkušenosti
strojaři.**



$\leq 0,003$



ŽADNÉ
NASTAVOVÁNÍ



ŽADNÉ ZBYTEČNÉ
NIČENÍ UPÍNAČŮ



ŽADNÉ TEPLLO
PŘI UPÍNÁNÍ



ŽADNÁ ZTRÁTA
UPÍNAČÍ SÍLY

► S ČÍM MNĚ TO POMŮŽE?



JEDNODUCHOST

- vhodné i pro úplné nováčky
- automatické upnutí nástroje
- žádné nastavování



PŘESNOST

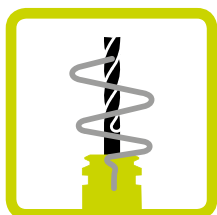
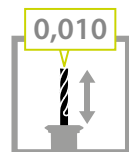
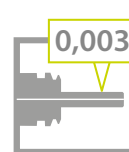

TLUMENÍ VIBRACÍ

- nižší spotřeba nástrojů
- rychlejší obrábění = zvýšení produktivity
- vyšší kvalita povrchu obrobku
- prohlédněte si graf níže



MAXIMÁLNÍ UPÍNAČÍ SÍLA

- minimalizace vytažení nástroje z upínače
- provedení secuRgrip = 100% bezpečnost proti vytažení nástroje



VYSOKÁ FLEXIBILITA

- snadné upnutí stopek od \varnothing 0,2 mm
- snadné upnutí různých materiálů stopek
- i pro liché \varnothing stopek: např. 7, 9, 11, 13, ...

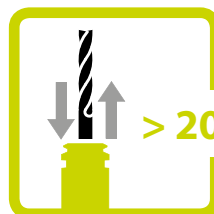

VYSOKÁ ŽIVOTNOST UPÍNAČŮ

- **> 20 000 x**
- stejná přesnost i upínací síla i po 20 000 upínacích cyklech

ZVÝŠENÍ ŽIVOTNOSTI NÁSTROJŮ

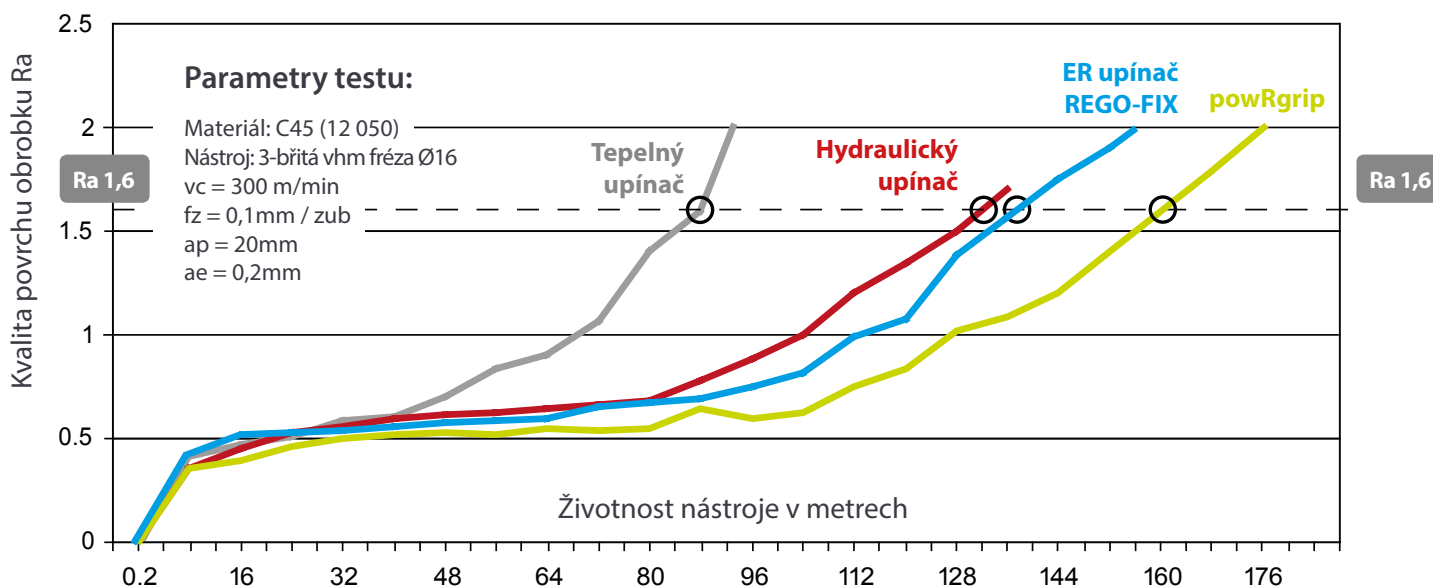

▶ JAK TO FUNGUJE?

Velmi jednoduše.
Pouhým MECHANICKÝM zatlačením
kuželové kleštiny (1:100) do upínače.

Prohlédněte si videa na
www.pm-tech.cz/powrgrip

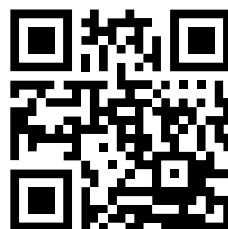

VLOŽÍTE DO JEDNOTKY.

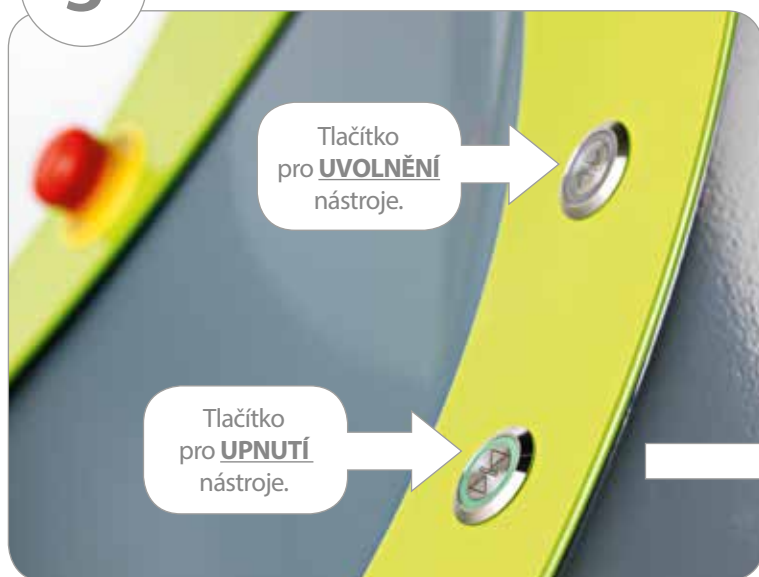
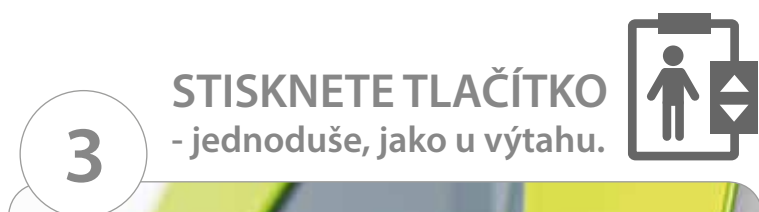

4

10 vteřin ...
A MÁTE UPNUTO!
(pro uvolnění nástroje je postup opačný)

► Z ČEHO SI MŮŽU VYBÍRAT?

A VELIKOSTI KLEŠTIN a UPÍNAČŮ

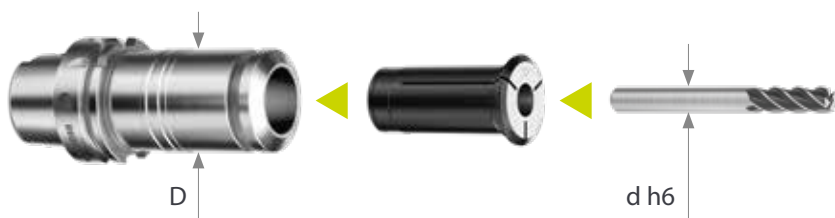

Velikost PG	D (mm)	Rozsah upínání d h6 (mm)
PG 6	Ø10	0,2 - 3
PG 10	Ø16	0,2 - 6
PG 15	Ø24	3 - 10
PG 25	Ø40	3 - 20
PG 32	Ø50	6 - 25



Každé velikosti PG odpovídají samostatné upínací čelisti.



B UPÍNAČE

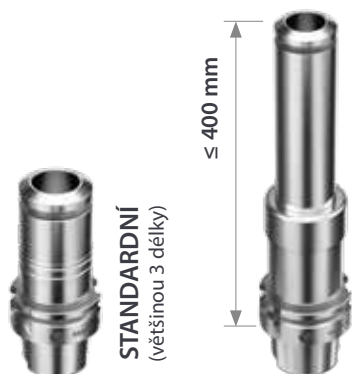

Pro LETECKÝ průmysl



secuRgrip

100% bezpečnost proti vyražení nástroje



ZÁVITOVÉ
Softsynchro

D KLEŠTINY



C PROVEDENÍ UPÍNAČŮ

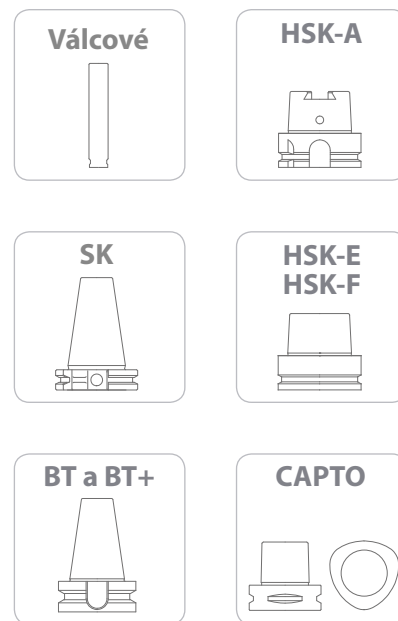

► CHCI TO VYZKOUŠET, CO MÁM UDĚLAT ?

Kontaktujte nás.
Domluvíme se co a jak.











235 350 808



info@pm-tech.cz

Obsah

	Přehled	Stránka katalogu
upínače SK		str. 6-7
upínače BT		str. 8-9
upínače HSK		str. 10-11
upínače PSC		str. 12
upínače ZÁVITOVÉ		str. 13
KLEŠTINY		str. 14-17
secuRgrip®		str. 18-19
PG jednotky		str. 20

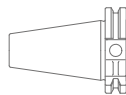

REGO-FIX
NOVÉ
NIŽŠÍ
CENY

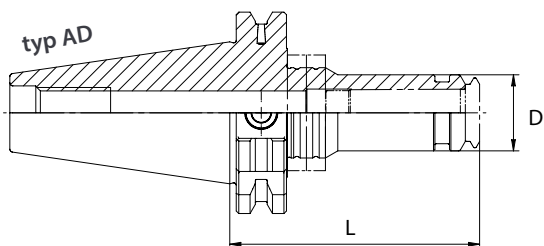

SK

BT

HSK

CAPTO

ZÁVITOVÉ

KLEŠŤINY

secuRgrip®

PG JEDNOTKY

Upínač	Typ	L (mm)	D (mm)	Objednací číslo Typ AD	Kč/ks bez DPH	Objednací číslo Typ AD+B	Kč/ks bez DPH
SK30	PG 6	80	10	4230.70640		-	
	PG 10	60	16	2230.71020		-	
		73	16	4230.71030		-	
	PG 15	60	24	2230.71520		-	
		80	24	4230.71540		-	
		120	24	4230.71560		-	
		80	40	2230.72540		-	
PG 25	160	40	4230.72580		-		
SK40	PG 10	80	16	4240.71040		4240.71043	
		120	16	4240.71060		4240.71063	
		160	16	4240.71080		4240.71083	
	PG 15	72	24	2240.71530		2240.71533	
		80	24	4240.71540		4240.71543	
		120	24	4240.71560		4240.71563	
		160	24	4240.71580		4240.71583	
	PG 25	72	40	2240.72530		2240.72533	
		80	40	4240.72540		4240.72543	
		120	40	4240.72560		4240.72563	
		160	40	4240.72580		4240.72583	
	PG 32	80	50	2240.73240		2240.73243	
SK50	PG 25	81	40	2250.72540		2250.72543	
		100	40	4250.72550		4250.72553	
		160	40	4250.72580		4250.72583	
		200	40	4250.72590		4250.72593	
	PG 32	80	50	2250.73240		2250.73243	

Vyvážení: SK30 » až do 30 000 min⁻¹ / SK40 » G2,5 / 22 000 min⁻¹ / SK50 » G2,5 / 22 000 min⁻¹

REGO-FIX
NOVÉ
NIŽŠÍ
CENY

SK powRgrip® upínače EXTRA DLOUHÉ
s SK stopkou

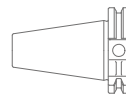

REGO-FIX
NOVÉ
NIŽŠÍ
CENY

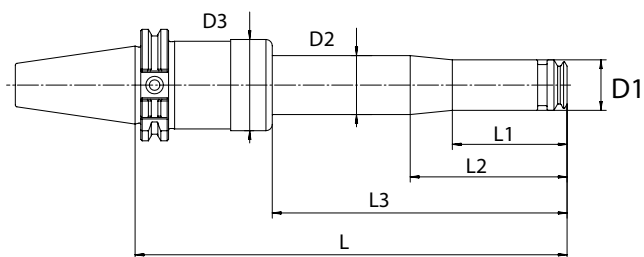

Upínač	Typ	D1 (mm)	D2 (mm)	D3 (mm)	L1 (mm)	L2 (mm)	L3 (mm)	L (mm)	Objednáací číslo Typ AD	Kč/ks bez DPH
SK40	PG 10	16	28	45,65	31	84	140	220	8842.71050	
		16	28	45,65	31	84	140	260	8842.71090	
		16	28	45,65	31	84	140	300	8842.71130	
		16	28	45,65	31	124	240	320	8842.71150	
		16	28	45,65	31	124	240	360	8842.71190	
		16	28	45,65	31	124	240	400	8842.71230	
	PG 15	24	28	45,65	55	75	140	220	8842.73050	
		24	28	45,65	55	75	140	260	8842.73090	
		24	28	45,65	55	75	140	300	8842.73130	
		24	28	45,65	55	125	240	320	8842.73150	
		24	28	45,65	55	125	240	360	8842.73190	
	PG 25	40	-	54,80	-	-	140	220	8842.76050	
		40	-	54,80	-	-	240	320	8842.76150	
	SK50	PG 10	16	28	45,65	31	84	140	240	8852.71070
16			28	45,65	31	84	140	300	8852.71130	
16			28	45,65	31	124	240	340	8852.71170	
16			28	45,65	31	124	240	400	8852.71230	
PG 15		24	28	45,65	55	75	140	240	8852.73070	
		24	28	45,65	55	75	140	300	8852.73130	
		24	28	45,65	55	125	240	340	8852.73170	
		24	28	45,65	55	125	240	400	8852.73230	
PG 25		40	-	54,80	-	-	240	320	8852.76150	

Vyvážení: G2,5 / 5 000 min⁻¹

SK

BT

HSK

CAPTO

ZÁVITOVÉ

KLEŠTINY

secuRgrip®

PG JEDNOTKY

BT powRgrip® upínače s BT stopkou

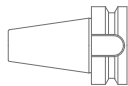

REGO-FIX
NOVÉ
NIŽŠÍ
CENY

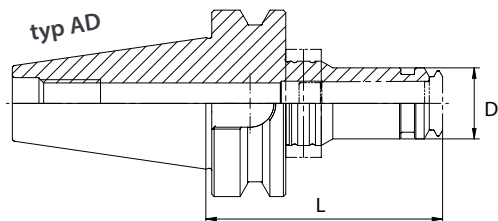

SK	BT	HSK	CAPT0	ZÁVITOVÉ	KLEŠŤINY	secuRgrip®	PG JEDNOTKY
Upínač	Typ	L (mm)	D (mm)	Objednací číslo Typ AD	Kč/ks bez DPH	Objednací číslo Typ AD+B	Kč/ks bez DPH
BT30	PG 6	50	10	2130.70610		-	
		80	10	4130.70640		-	
	PG 10	62	16	2130.71020		-	
		80	16	4130.71040		-	
		120	16	4130.71060		-	
		160	16	4130.71080		-	
	PG 15	70	24	4130.71530		-	
		120	24	4130.71560		-	
	PG 25	80	40	4130.72540		-	
		120	40	4130.72560		-	
		160	40	4130.72580		-	
BT30 BIG-Plus	PG 10	80	16	-		4130.71046	
	PG 15	70	24	-		4130.71536	
	PG 25	80	40	-		4130.72546	
		160	40	-		4130.72586	
BT40	PG 10	80	16	4140.71040		4140.71043	
		120	16	4140.71060		4140.71063	
		160	16	4140.71080		4140.71083	
	PG 15	80	24	4140.71540		4140.71543	
		120	24	4140.71560		4140.71563	
		160	24	4140.71580		4140.71583	
	PG 25	80	40	4140.72540		4140.72543	
		120	40	4140.72560		4140.72563	
		160	40	4140.72580		4140.72583	
		PG 32	86	50	2140.73240		2140.73243
BT40 BIG-Plus	PG 10	80	16	-		4140.71046	
		120	16	-		4140.71066	
	PG 15	80	24	-		4140.71546	
		120	24	-		4140.71566	
	PG 25	80	40	-		4140.72546	
		120	40	-		4140.72566	
		160	40	-		4140.72586	
BT50	PG 10	120	16	4150.71060		-	
		160	16	4150.71080		-	
	PG 15	120	24	4150.71560		-	
		160	24	4150.71580		-	
	PG 25	100	40	2150.72550		-	
		120	40	4150.72560		-	
		160	40	4150.72580		-	
		200	40	4150.72590		-	
PG 32	100	50	2150.73250		-		
BT50 BIG-Plus	PG 25	120	40	-		4150.72566	
		160	40	-		4150.72586	

Vyvážení: BT30 » až do 30 000 min⁻¹ / BT40 » G2,5 / 22 000 min⁻¹ / BT50 » G2,5 / 22 000 min⁻¹

BT powRgrip® upínače EXTRA DLOUHÉ s BT stopkou

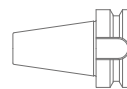

REGO-FIX
NOVÉ
NIŽŠÍ
CENY

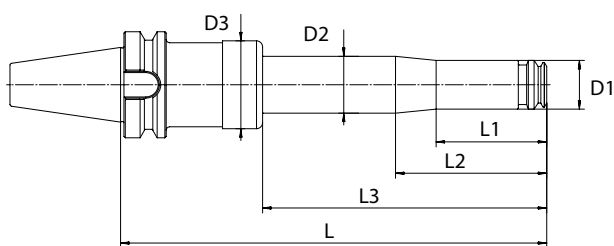

Upínač	Typ	D1 (mm)	D2 (mm)	D3 (mm)	L1 (mm)	L2 (mm)	L3 (mm)	L (mm)	Objednáací číslo Typ AD	Kč/ks bez DPH
BT40	PG 10	16	28	45,65	31	84	140	220	8841.71050	
		16	28	45,65	31	84	140	260	8841.71090	
		16	28	45,65	31	84	140	300	8841.71130	
		16	28	45,65	31	124	240	320	8841.71150	
		16	28	45,65	31	124	240	360	8841.71190	
		16	28	45,65	31	124	240	400	8841.71230	
	PG 15	24	28	45,65	55	75	140	220	8841.73050	
		24	28	45,65	55	75	140	260	8841.73090	
		24	28	45,65	55	75	140	300	8841.73130	
		24	28	45,65	55	125	240	320	8841.73150	
		24	28	45,65	55	125	240	360	8841.73190	
		24	28	45,65	55	125	240	400	8841.73230	
	PG 25	40	-	54,80	-	-	140	226	8841.76050	
		40	-	54,80	-	-	240	326	8841.76150	
BT50	PG 10	16	28	45,65	31	84	140	240	8851.71070	
		16	28	45,65	31	84	140	260	8851.71090	
		16	28	45,65	31	84	140	300	8851.71130	
		16	28	45,65	31	124	240	340	8851.71170	
		16	28	45,65	31	124	240	360	8851.71190	
		16	28	45,65	31	124	240	400	8851.71230	
	PG 15	24	28	45,65	55	75	140	240	8851.73070	
		24	28	45,65	55	75	140	260	8851.73090	
		24	28	45,65	55	75	140	300	8851.73130	
		24	28	45,65	55	125	240	340	8851.73170	
		24	28	45,65	55	125	240	360	8851.73190	
		24	28	45,65	55	125	240	400	8851.73230	
	PG 25	40	-	54,80	-	-	140	240	8851.76070	
		40	-	54,80	-	-	240	340	8851.76170	

Vyvážení: G2,5 / 5 000 min⁻¹

▶ HSK powRgrip® upínače s HSK stopkou

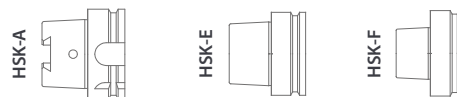

REGO-FIX
NOVÉ
NIŽŠÍ
CENY

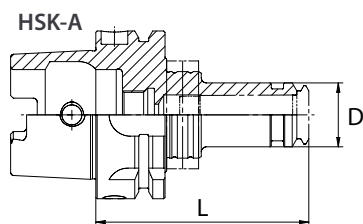

▶ HSK-A

Upínač	Typ	L (mm)	D (mm)	Objednací číslo
HSK-A32	PG 10	60	16	2532.71020
	PG 15	75	24	2532.71530
HSK-A40	PG 6	48	10	2540.70610
		80	10	4540.70640
	PG 10	62	16	2540.71020
		80	24	4540.71540
		100	40	4540.72550
HSK-A50	PG 10	80	16	4550.71040
	PG 15	80	24	4550.71540
	PG 25	100	40	4550.72550
HSK-A63	PG 6	80	10	4563.70640
		80	16	4563.71040
		120	16	4563.71060
		160	16	4563.71080
		200	16	4563.71090
	PG 10	80	24	4563.71540
		120	24	4563.71560
		160	24	4563.71580
		100	40	4563.72550
		120	40	4563.72560
	PG 25	160	40	4563.72580
		200	40	4563.72590
		100	50	2563.73250
		120	50	4563.73260
		HSK-A80	PG 15	85
PG 25	100		40	4580.72550
PG 32	105		50	4580.73250
HSK-A100	PG 10	85	16	4500.71040
		160	16	4500.71080
	PG 15	85	24	4500.71540
		160	24	4500.71580
	PG 25	100	40	4500.72550
		120	40	NOVÉ 4500.72560
		160	40	4500.72580
		200	40	4500.72590
		106	50	4500.73250
		120	50	NOVÉ 4500.73260
	PG 32	160	50	4500.73280
		200	50	4500.73290
na vyžádání				
HSK-A125	na vyžádání			

▶ HSK-E

Upínač	Typ	L (mm)	D (mm)	Objednací číslo	Kč/ks bez DPH
HSK-E25	PG 6	43	10	2525.70614	
	PG 10	55	16	2525.71014	
HSK-E32	PG 6	48	10	2532.70614	
		80	10	2532.70644	
	PG 10	60	16	2532.71024	
		80	16	2532.71044	
		75	24	2532.71534	
HSK-E40	PG 6	48	10	2540.70614	
		80	10	4540.70644	
	PG 10	62	16	2540.71024	
		80	16	4540.71044	
		120	16	4540.71064	
		160	16	4540.71084	
	PG 15	80	24	4540.71544	
		120	24	4540.71564	
		90	40	2540.72544	
		100	40	4540.72554	
HSK-E50	PG 6	80	10	4550.70644	
		80	16	4550.71044	
	PG 10	120	16	4550.71064	
		160	16	4550.71084	
		80	24	4550.71544	
	PG 15	120	24	4550.71564	
		100	40	4550.72554	
		HSK-E63	PG 15	80	24
PG 25	100		40	4563.72554	

▶ HSK-F

Upínač	Typ	L (mm)	D (mm)	Objednací číslo	Kč/ks bez DPH
HSK-FG3	PG 10	80	16	4563.71045	
		120	16	4563.71065	
		160	16	4563.71085	
	PG 15	80	24	4563.71545	
		120	24	4563.71565	
		160	24	4563.71585	
	PG 25	100	40	4563.72555	
		160	40	4563.72585	
		100	50	2563.73255	

Vyvážení: HSK25 » až do 90 000 min⁻¹ / HSK32 » až do 60 000 min⁻¹ / HSK40 » až do 45 000 min⁻¹ / HSK50 » až do 36 000 min⁻¹
 HSK63 / HSK80 / HSK100 / HSK125 » G2,5 / 25 000 min⁻¹

▶ HSK powRgrip® upínače EXTRA DLOUHÉ s HSK stopkou



REGO-FIX
NOVÉ
NIŽŠÍ
CENY

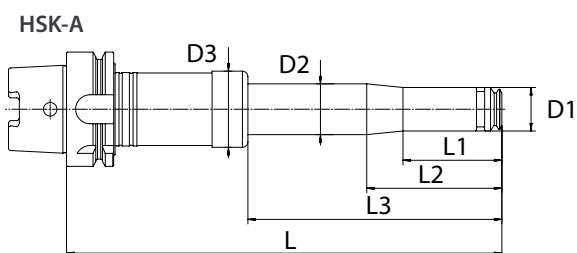

▶ HSK-A

Upínač	Typ	D1 (mm)	D2 (mm)	D3 (mm)	L1 (mm)	L2 (mm)	L3 (mm)	L (mm)	Objednáací číslo Typ AD	Kč/ks bez DPH
HSK-A63	PG 10	16	28	45,65	31	84	140	240	8865.71070	
		16	28	45,65	31	84	140	260	8865.71090	
		16	28	45,65	31	84	140	300	8865.71130	
		16	28	45,65	31	124	240	340	8865.71170	
		16	28	45,65	31	124	240	360	8865.71190	
		16	28	45,65	31	124	240	400	8865.71230	
	PG 15	24	28	45,65	55	75	140	240	8865.73070	
		24	28	45,65	55	75	140	260	8865.73090	
		24	28	45,65	55	75	140	300	8865.73130	
		24	28	45,65	55	125	240	340	8865.73170	
		24	28	45,65	55	125	240	360	8865.73190	
		24	28	45,65	55	125	240	400	8865.73230	
	PG 25	40	-	54,80	-	-	140	240	8865.76070	
		40	-	54,80	-	-	140	260	8865.76090	
40		-	54,80	-	-	240	340	8865.76170		
40		-	54,80	-	-	240	360	8865.76190		
HSK-A100	PG 10	16	28	45,65	31	84	140	240	8885.71070	
		16	28	45,65	31	84	140	300	8885.71130	
		16	28	45,65	31	124	240	340	8885.71170	
		16	28	45,65	31	124	240	400	8885.71230	
	PG 15	24	28	45,65	55	75	140	240	8885.73070	
		24	28	45,65	55	75	140	300	8885.73110	
		24	28	45,65	55	125	240	340	8885.73170	
		24	28	45,65	55	125	240	400	8885.73230	
		40	-	54,80	-	-	140	246	8885.76070	
		40	-	54,80	-	-	240	346	8885.76170	

Vyvážení: G2,5 / 5 000 min⁻¹

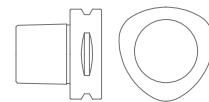

STANDARDNÍ

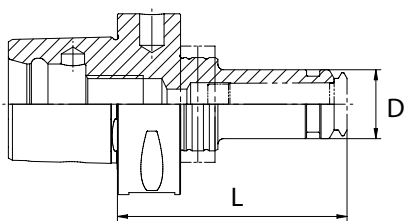

EXTRA DLOUHÉ

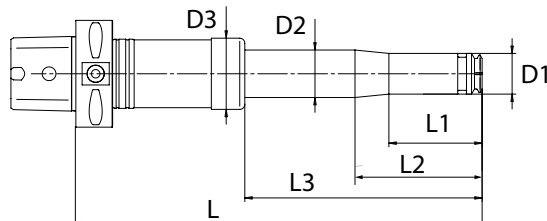

REGO-FIX
**NOVÉ
NIŽŠÍ
CENY**

STANDARDNÍ

Upínač	Typ	L (mm)	D (mm)	Objednací číslo	Kč/ks bez DPH
CAPTO-C3	PG 6	45	10	2803.70610	
	PG 10	55	16	2803.71010	
	PG 15	67	24	2803.71520	
CAPTO-C4	PG 6	48	10	2804.70610	
	PG 10	60	16	2804.71020	
		80	16	4804.71040	
	PG 15	62	24	2804.71520	
		80	24	4804.71540	
CAPTO-C5	PG 6	80	10	4805.70640	
	PG 10	60	16	2805.71020	
		80	16	4805.71040	
		120	16	4805.71060	
	PG 15	65	24	2805.71520	
		80	24	4805.71540	
		120	24	4805.71560	
	PG 25	80	40	2805.72540	
		100	40	4805.72550	

STANDARDNÍ

Upínač	Typ	L (mm)	D (mm)	Objednací číslo	Kč/ks bez DPH
CAPTO-C6	PG 10	80	16	4806.71040	
		120	16	4806.71060	
		160	16	4806.71080	
	PG 15	80	24	4806.71540	
		120	24	4806.71560	
		160	24	4806.71580	
	PG 25	85	40	2806.72540	
		100	40	4806.72550	
		120	40	4806.72560	
PG 32	160	40	4806.72580		
	90	50	2806.73240		
CAPTO-C8	PG 25	92	40	2808.72540	
	PG 32	90	50	2808.73240	

Vyvážení: G2,5 / 25 000 min⁻¹

EXTRA DLOUHÉ

Upínač	Typ	D1 (mm)	D2 (mm)	D3 (mm)	L1 (mm)	L2 (mm)	L3 (mm)	L (mm)	Objednací číslo Typ AD	Kč/ks bez DPH	
CAPTO-C6	PG10	16	28	45,65	31	84	140	225	8886.71050		
		16	28	45,65	31	84	140	240	8886.71070		
		16	28	45,65	31	84	140	260	8886.71090		
		16	28	45,65	31	84	140	300	8886.71130		
		16	28	45,65	31	124	240	325	8886.71150		
		16	28	45,65	31	124	240	340	8886.71170		
		16	28	45,65	31	124	240	360	8886.71190		
		16	28	45,65	31	124	240	400	8886.71230		
		24	28	45,65	55	75	140	225	8886.73050		
	PG15	24	28	45,65	55	75	140	240	8886.73070		
		24	28	45,65	55	75	140	260	8886.73090		
		24	28	45,65	55	75	140	300	8886.73130		
		24	28	45,65	55	125	240	325	8886.73150		
		24	28	45,65	55	125	240	340	8886.73170		
		24	28	45,65	55	125	240	360	8886.73190		
		24	28	45,65	55	125	240	400	8886.73230		
		PG25	40	-	54,80	-	-	140	230	8886.76060	
			40	-	54,80	-	-	240	330	8886.76160	
	CAPTO-C8	PG10	16	28	45,65	31	84	140	232	8888.71060	
16			28	45,65	31	124	240	332	8888.71160		
PG15		24	28	45,65	55	75	140	232	8888.73060		
		24	28	45,65	55	75	240	332	8888.73160		
PG25		40	-	54,80	-	-	140	230	8888.76060		
		40	-	54,80	-	-	240	330	8888.76160		

Vyvážení: G2,5 / 5 000 min⁻¹

ZÁVITOVÉ powRgrip® upínače ZÁVITOVÉ

▶ HSK-A - Softsynchro®

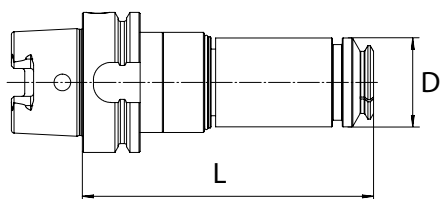

REGO-FIX▲
NOVÉ
NIŽŠÍ
CENY

Upínač	Typ	L (mm)	D (mm)	Tlak (mm)	Tah (mm)	Objednací číslo	Kč/ks bez DPH
HSK-A63	PG 15	114,5	24	0,5	0,5	2563.61507	
	PG 25	131	40	0,5	0,5	2563.62507	

▶ VÁLCOVÉ - Softsynchro®

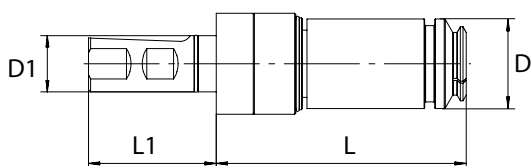

Upínač	Typ	L (mm)	L1 (mm)	D (mm)	D1 (mm)	Tlak (mm)	Tah (mm)	Objednací číslo	Kč/ks bez DPH
CYL 25	PG 15	92	57	24	25	0,5	0,5	2625.61507	
	PG 25	109,5	57	40	25	0,5	0,5	2625.62507	

▶ VÁLCOVÉ S AXIÁLNÍ KOMPENZACÍ

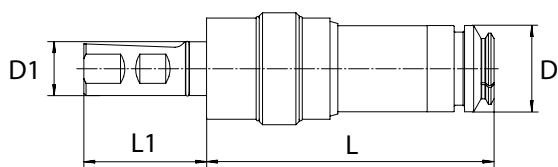

Upínač	Typ	L (mm)	L1 (mm)	D (mm)	D1 (mm)	Tlak (mm)	Tah (mm)	Objednací číslo	Kč/ks bez DPH
CYL 25	PG 15	99,5	57	24	25	5	7,5	2625.61508	
	PG 25	134	57	40	25	7	10	2625.62508	

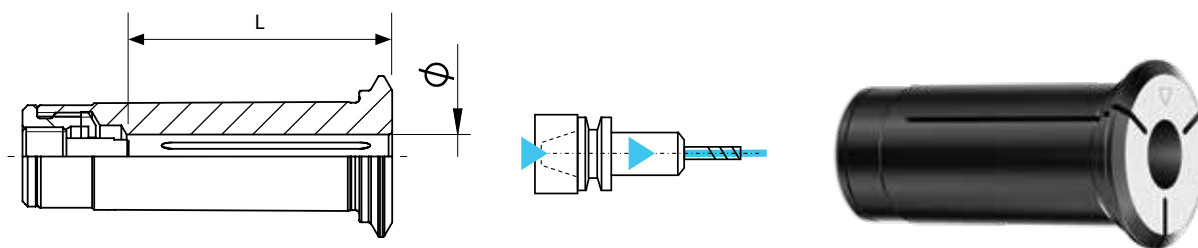

SK	Ø (mm) h6	PG 6 REGO-FIX®		PG 10 REGO-FIX®		PG 15 REGO-FIX®		PG 25 REGO-FIX®		PG 32 REGO-FIX®	
		Objednáací číslo	Kč/ks bez DPH	Objednáací číslo	Kč/ks bez DPH	Objednáací číslo	Kč/ks bez DPH	Objednáací číslo	Kč/ks bez DPH	Objednáací číslo	Kč/ks bez DPH
BT	2,0	1706.02000		1710.02000							
	2,5	1706.02500		1710.02500							
	3,0	1706.03000		1710.03000		1715.03000		1725.03000			
	3,5			1710.03500		1715.03500		1725.03500			
	4,0	1706.04000		1710.04000		1715.04000		1725.04000			
HSK	4,5			1710.04500		1715.04500		1725.04500			
	5,0			1710.05000		1715.05000		1725.05000			
	5,5			1710.05500		1715.05500		1725.05500			
	6,0			1710.06000		1715.06000		1725.06000		1732.06000	
	7,0					1715.07000		1725.07000		1732.07000	
	8,0					1715.08000		1725.08000		1732.08000	
	9,0					1715.09000		1725.09000		1732.09000	
	10,0					1715.10000		1725.10000		1732.10000	
	11,0							1725.11000		1732.11000	
	12,0							1725.12000		1732.12000	
CAPTO	13,0							1725.13000			
	14,0							1725.14000		1732.14000	
	15,0							1725.15000			
	16,0							1725.16000		1732.16000	
	18,0							1725.18000		1732.18000	
	20,0							1725.20000		1732.20000	
	22,0									1732.22000	
ZÁVITOVÉ	25,0									1732.25000	

Maximální a minimální možné zasunutí nástroje do kleštiny

Ø (mm) h6	PG 6 REGO-FIX®		PG 10 REGO-FIX®		PG 15 REGO-FIX®		PG 25 REGO-FIX®		PG 32 REGO-FIX®	
	L min. (mm)	L max. (mm)	L min. (mm)	L max. (mm)	L min. (mm)	L max. (mm)	L min. (mm)	L max. (mm)	L min. (mm)	L max. (mm)
0,2 - 1	21,5	26,5	19,0	22,0	-	-	-	-	-	-
1,5	23,5	26,5	15,0	18,0	-	-	-	-	-	-
2 - 2,5	24,0	26,5	24,0	30,0	-	-	-	-	-	-
3 - 5	-	-	24,0	30,0	25,0	32,0	25,0	32,0	-	-
6	-	-	30,0	35,5	33,0	40,0	33,0	40,0	33,6	42,5
7 - 9	-	-	-	-	33,0	40,0	33,0	40,0	33,6	42,5
10	-	-	-	-	37,0	40,5	37,0	44,0	37,6	46,5
11	-	-	-	-	-	-	37,0	44,0	37,6	46,5
12 - 14	-	-	-	-	-	-	42,0	49,0	42,6	51,5
16 - 18	-	-	-	-	-	-	45,0	50,0	45,6	54,5
20	-	-	-	-	-	-	47,0	50,0	47,6	56,5
22	-	-	-	-	-	-	-	-	47,6	56,5
25	-	-	-	-	-	-	-	-	53,6	62,5

▶ PG-CF powRgrip® KLEŠTINY S CHLADÍCÍMI KANÁLKY

REGO-FIX
NOVÉ
NIŽŠÍ
CENY

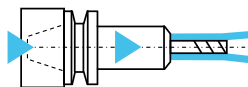
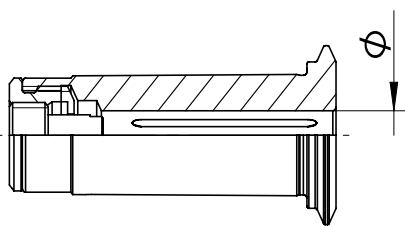

Ø (mm) h6	PG 10-CF REGO-FIX®		PG 15-CF REGO-FIX®		PG 25-CF REGO-FIX®		PG 32-CF REGO-FIX®	
	Objednáací číslo	Kč/ks bez DPH	Objednáací číslo	Kč/ks bez DPH	Objednáací číslo	Kč/ks bez DPH	Objednáací číslo	Kč/ks bez DPH
2,0	1710.02002							
3,0	1710.03002		1715.03002		1725.03002			
4,0	1710.04002		1715.04002		1725.04002			
5,0	1710.05002		1715.05002		1725.05002			
6,0	1710.06002		1715.06002		1725.06002		1732.06002	
7,0			1715.07002		1725.07002		1732.07002	
8,0			1715.08002		1725.08002		1732.08002	
9,0			1715.09002		1725.09002		1732.09002	
10,0			1715.10002		1725.10002		1732.10002	
11,0					1725.11002		1732.11002	
12,0					1725.12002		1732.12002	
13,0					1725.13002			
14,0					1725.14002		1732.14002	
15,0					1725.15002			
16,0					1725.16002		1732.16002	
18,0					1725.18002		1732.18002	
20,0					1725.20002		1732.20002	
22,0							1732.22002	
25,0							1732.25002	

▶ PG-MB powRgrip® KLEŠTINY S MIKRO-OTVORY

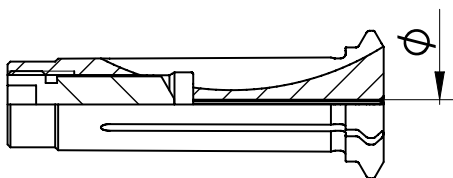

Ø (mm) h6	PG 6-MB REGO-FIX®		PG 10-MB REGO-FIX®	
	Objednáací číslo	Kč/ks bez DPH	Objednáací číslo	Kč/ks bez DPH
0,2	1706.00209		1710.00209	
0,3	1706.00309		1710.00309	
0,4	1706.00409		1710.00409	
0,5	1706.00509		1710.00509	
0,6	1706.00609		1710.00609	
0,7	1706.00709		1710.00709	
0,8	1706.00809		1710.00809	
0,9	1706.00909		1710.00909	
1,0	1706.01009		1710.01009	
1,5	1706.01509		1710.01509	

PG-S powRgrip® KLEŠTINY KRÁTKÉ

REGO-FIX
NOVÉ
NIŽŠÍ
CENY

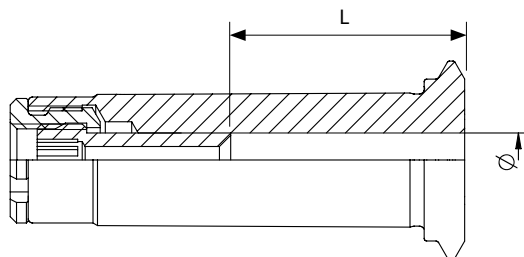

SK	Ø (mm) h6	PG 6-S REGO-FIX®		PG 10-S REGO-FIX®		PG 15-S REGO-FIX®		PG 25-S REGO-FIX®		PG 32-S REGO-FIX®	
		Objednáací číslo	Kč/ks bez DPH	Objednáací číslo	Kč/ks bez DPH	Objednáací číslo	Kč/ks bez DPH	Objednáací číslo	Kč/ks bez DPH	Objednáací číslo	Kč/ks bez DPH
BT	3,0	1706.03008		1710.03008				1725.04008			
	4,0			1710.04008		1715.04008		1725.04008			
	5,0					1715.05008					
	6,0			1710.06008		1715.06008		1725.06008			
	8,0					1715.08008		1725.08008			
	10,0					1715.10008		1725.10008			
HSK	12,0							1725.12008		1732.12008	
	14,0							1725.14008			
	16,0							1725.16008		1732.16008	
	20,0							1725.20008		1732.20008	
	25,0									1732.25008	

Maximální a minimální zasunutí nástroje do kleštiny

CAPTO	Ø (mm) h6	PG 6-S REGO-FIX®		PG 10-S REGO-FIX®		PG 15-S REGO-FIX®		PG 25-S REGO-FIX®		PG 32-S REGO-FIX®	
		L min. (mm)	L max. (mm)	L min. (mm)	L max. (mm)	L min. (mm)	L max. (mm)	L min. (mm)	L max. (mm)	L min. (mm)	L max. (mm)
ZÁVITOVÉ KLEŠTINY	3,0	17,0	20,0	20,5	26,0	-	-	-	-	-	-
	4,0	-	-	20,5	26,0	18,0	25,0	-	-	-	-
	5,0	-	-	23,5	29,0	-	-	-	-	-	-
	6,0	-	-	23,5	29,0	26,0	33,0	26,0	33,0	-	-
	8,0	-	-	-	-	26,0	33,0	26,0	33,0	-	-
	10,0	-	-	-	-	31,0	38,0	30,0	38,0	-	-
	12,0	-	-	-	-	-	-	35,0	43,0	32,0	40,0
	14,0	-	-	-	-	-	-	35,0	43,0	35,0	43,0
	16,0	-	-	-	-	-	-	38,0	46,0	35,0	43,5
	20,0	-	-	-	-	-	-	40,0	47,5	37,0	45,5
	25,0	-	-	-	-	-	-	-	-	41,0	49,5

PG-L powRgrip® KLEŠTINY DLOUHÉ

REGO-FIX
NOVÉ
NIŽŠÍ
CENY

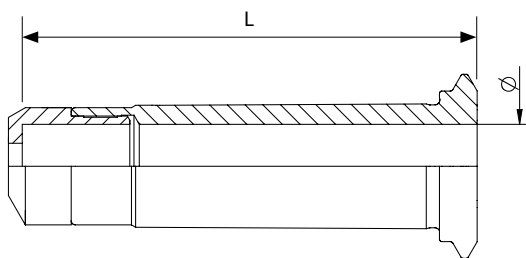

Maximální a minimální možné zasunutí nástroje do kleštiny

Ø (mm) h6	PG 15-L		PG 25-L		PG 32-L	
	REGO-FIX®		REGO-FIX®		REGO-FIX®	
	Objednáací číslo	Kč/ks bez DPH	Objednáací číslo	Kč/ks bez DPH	Objednáací číslo	Kč/ks bez DPH
4,0	1715.04001					
5,0	1715.05001					
6,0	1715.06001		1725.06001			
8,0	1715.08001		1725.08001			
10,0	1715.10001		1725.10001			
12,0			1725.12001		1732.12001	
14,0			1725.14001			
16,0			1725.16001		1732.16001	
20,0			1725.20001		1732.20001	
25,0					1732.25001	

Ø (mm) h6	PG 15-L		PG 25-L		PG 32-L	
	REGO-FIX®		REGO-FIX®		REGO-FIX®	
	L min. (mm)	L max. (mm)	L min. (mm)	L max. (mm)	L min. (mm)	L max. (mm)
4,0	25,0	53,0	-	-	-	-
5,0	25,0	53,0	-	-	-	-
6,0	33,0	53,0	33,0	65,0	-	-
8,0	33,0	53,0	33,0	65,0	-	-
10,0	37,0	53,0	37,0	65,0	-	-
12,0	-	-	42,0	65,0	40,5	70,0
14,0	-	-	42,0	65,0	40,5	70,0
16,0	-	-	45,5	65,0	43,5	70,0
20,0	-	-	47,5	65,0	45,5	70,0
25,0	-	-	-	-	49,5	70,5

PG-TAP powRgrip® KLEŠTINY ZÁVITOVÉ

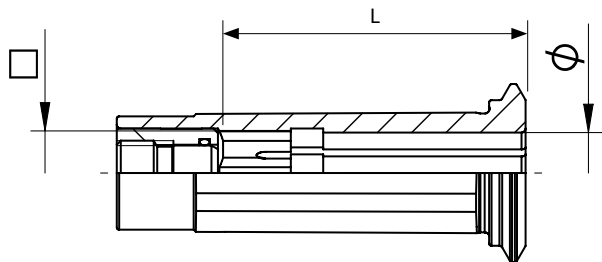

Maximální a minimální možné zasunutí nástroje do kleštiny

Ø (mm) h9	(mm)	PG 15-TAP		PG 25-TAP	
		REGO-FIX®		REGO-FIX®	
		Objednáací číslo	Kč/ks bez DPH	Objednáací číslo	Kč/ks bez DPH
3,5	2,7	1715.03505			
4,5	3,4	1715.04505			
6,0	4,9	1715.06005		1725.06005	
7,0	5,5	1715.07005			
8,0	6,2	1715.08005		1725.08005	
9,0	7,0	1715.09005		1725.09005	
10,0	8,0	1715.10005		1725.10005	
11,0	9,0			1725.11005	
12,0	9,0			1725.12005	
14,0	11,0			1725.14005	
16,0	12,0			1725.16005	

Ø (mm) h9	o (mm)	PG 15-TAP		PG 25-TAP	
		REGO-FIX®		REGO-FIX®	
		L min. (mm)	L max. (mm)	L min. (mm)	L max. (mm)
3,5	2,7	27,0	29,0	-	-
4,5	3,4	27,0	29,0	-	-
6,0	4,9	29,0	31,0	-	-
7,0	5,5	29,0	31,0	-	-
8,0	6,2	33,5	36,0	33,50	36,00
9,0	7,0	34,5	37,0	34,50	37,00
10,0	8,0	35,5	38,0	38,50	41,00
11,0	9,0	-	-	39,50	42,00
12,0	9,0	-	-	39,50	42,00
14,0	11,0	-	-	41,50	44,00
16,0	12,0	-	-	42,50	45,00

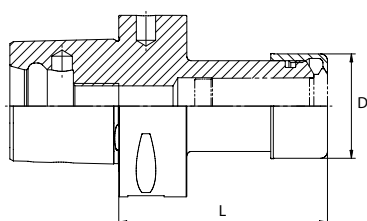
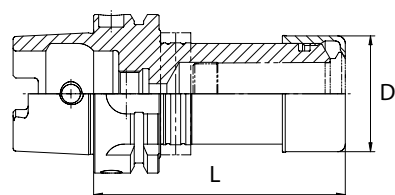
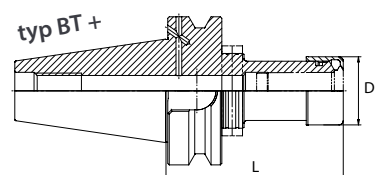
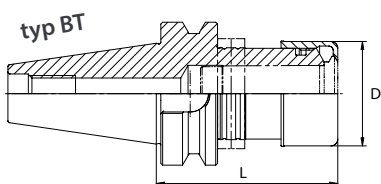
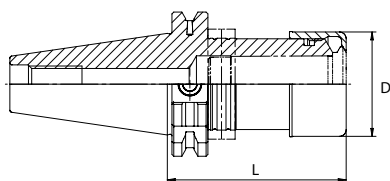

► **SK**

Upínač	Typ	L (mm)	D (mm)	Objednací číslo Typ AD	Kč/kus bez DPH
SK 40	PG 25	80	46	5240.72540	
		120	46	5240.72560	
		160	46	5240.72580	
	PG 32	80	55	5240.73240	
SK 50	PG 32	80	55	5250.73240	

► **BT**

Upínač	Typ	L (mm)	D (mm)	Objednací číslo Typ AD	Kč/kus bez DPH
BT 40	PG 25	80	46	5140.72540	
		120	46	5140.72560	
	PG 32	86	55	5140.73240	
BT 50	PG 25	100	46	5150.72550	
		120	46	5150.72560	
	PG 32	100	55	5150.73250	
BT+50	PG 25	120	46	5150.72566	

► **HSK-A**

Upínač	Typ	L (mm)	D (mm)	Objednací číslo Typ AD	Kč/kus bez DPH
HSK-A 63	PG 25	100	46	5563.72550	
		120	46	5563.72560	
		160	46	5563.72580	
		200	46	5563.72590	
	PG 32	100	55	5563.73250	
		120	55	5563.73260	
HSK-A 80	PG 32	105	55	5580.73250	
HSK-A 100	PG 25	100	46	5500.72550	
		160	46	5500.72580	
		200	46	5500.72590	
	PG 32	106	55	5500.73250	
		160	55	5500.73280	
		200	55	5500.73290	
HSK-A 125	na vyžádání				

► **PSC**

Upínač	Typ	L (mm)	D (mm)	Objednací číslo Typ AD	Kč/kus bez DPH
PSC-C8	PG 25	92	46	5808.72540	
	PG 32	90	55	5808.73240	

secuRgrip® upínače jsou dodávány včetně secuRgrip® bezpečnostní matice

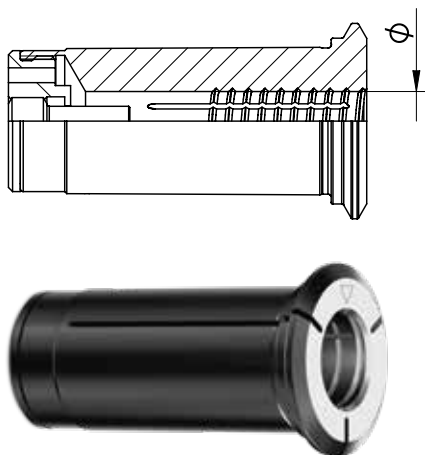

► secuRgrip® KLEŠTINY

Typ	Objednací číslo	Ø (mm)	Kč/kus bez DPH
PG 25 SG	1725.12004	12	
	1725.14004	14	
	1725.16004	16	
	1725.18004	18	
	1725.20004	20	
PG 32 SG	1732.12004	12	
	1732.14004	14	
	1732.16004	16	
	1732.18004	18	
	1732.20004	20	
	1732.25004	25	

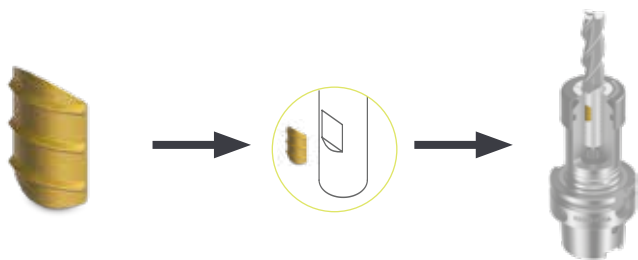

► secuRgrip® ZÁVITOVÉ VLOŽKY

Ø kleštiny (mm)	Objednací číslo	Kč/kus bez DPH
12	7694.12000	
14	7694.14000	
16	7694.16000	
18	7694.18000	
20	7694.20000	
25	7694.25000	

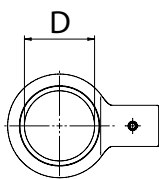

► secuRgrip® UPÍNACÍ HLAVICE

Typ	Objednací číslo	D (mm)	Kč/kus bez DPH
PG 25 SG	7655.25000	46	
PG 32 SG	7655.32000	55	

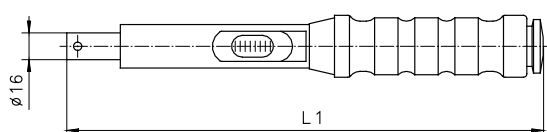

► MOMENTOVÝ KLÍČ

Typ	Objednací číslo	Rozsah (Nm)	L1 (mm)	Kč/kus bez DPH
TORCO-FIX-2	4420-01	20 - 200	465	

Pro utáhnutí bezpečnostní matice doporučujeme používat MOMENTOVÝ KLÍČ.

▶ PGU-9500 powRgrip® AUTOMATICKÁ upínací jednotka

REGO-FIX▲
NOVÉ
NIŽŠÍ
CENY



Upínací čelisti

Upínací čelisti pro AUTOMATICKOU powRgrip® upínací jednotku.

Typ	Objednáací číslo	Hmotnost (kg)	Kč/kus bez DPH
PG 6	7611.06900	3	
PG 10	7611.10900	3	
PG 15	7611.15900	3	
PG 25	7611.25900	3	
PG 32	7611.32900	3	

Typ jednotky	Objednáací číslo	Hmotnost (kg)	Kč/kus bez DPH
AUTOMATICKÁ	7610.95000	87	

Upínací čelisti nejsou součástí jednotky.

▶ PGU powRgrip® MANUÁLNÍ upínací jednotka



Upínací čelisti

Upínací čelisti pro MANUÁLNÍ powRgrip® upínací jednotku.

Typ	Objednáací číslo	Hmotnost (kg)	Kč/kus bez DPH
PG 6	7622.06000	0,8	
PG 10	7622.10000	0,8	
PG 15	7622.15000	0,8	
PG 25	7622.25000	0,8	

Typ jednotky	Objednáací číslo	Hmotnost (kg)	Kč/kus bez DPH
MANUÁLNÍ	7621.25069	18,2	

Upínací čelisti nejsou součástí jednotky.

SK
BT
HSK
CAPTO
ZÁVITOVÉ
KLEŠŤINY
secuRgrip®
PG JEDNOTKY