

**2019**  
Platné od 1. 6. 2019

**PM-TECH**

**reCool®**

A Vaše naháněčka  
má **za 5 minut**  
**vnitřní chlazení.**

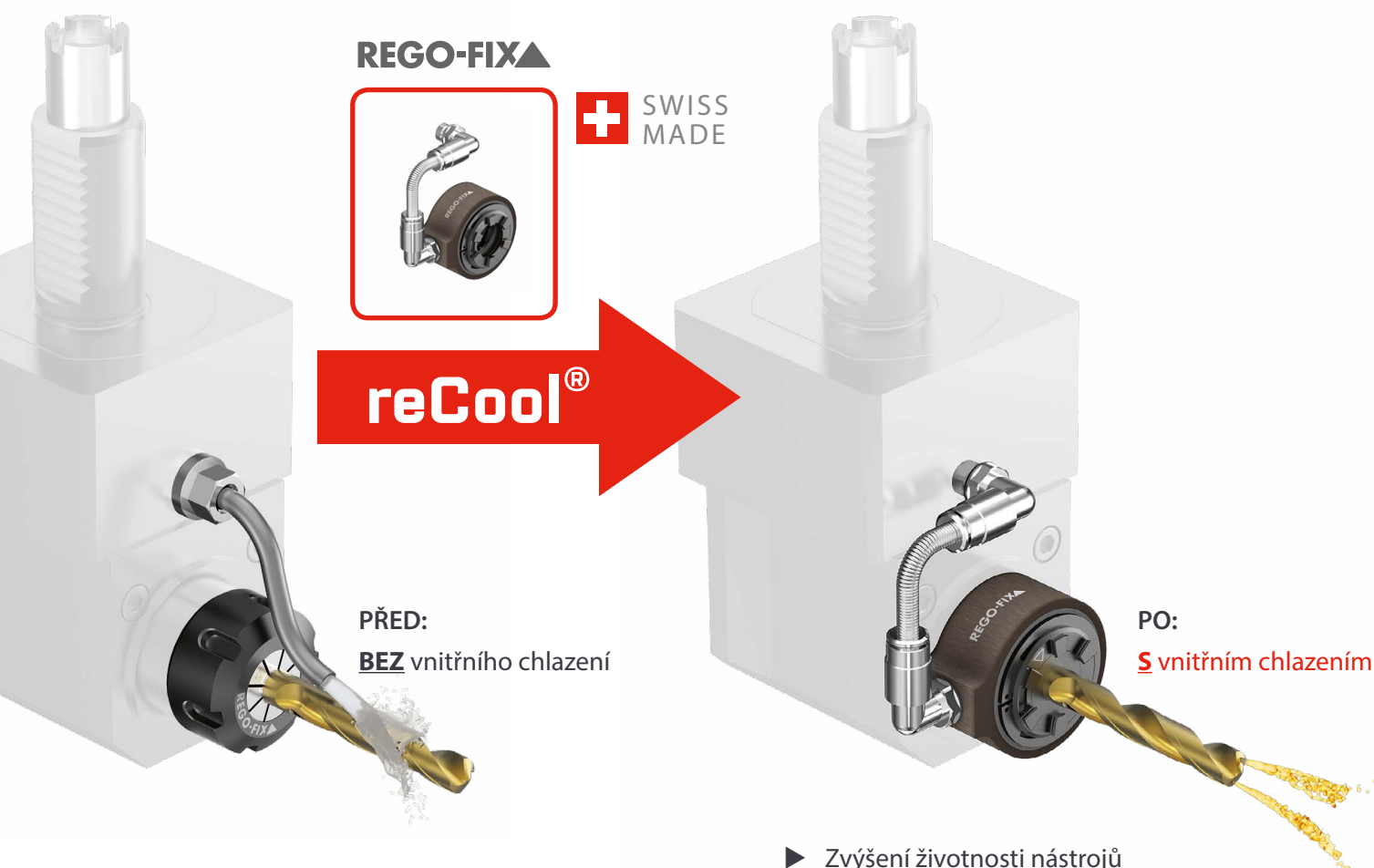

- ▶ Zvýšení životnosti nástrojů
- ▶ Zrychlení vrtání
- ▶ Výborný odvod třísek
- ▶ Jednoduchá a rychlá montáž

# ► JAK ZVOLIT SPRÁVNÝ reCool®?

Podle TYPU UPÍNAČE stopkového nástroje v soustruhu:

## NAHÁNĚNÁ JEDNOTKA

(točí se nástroj)

**STANDARDNÍ**  
matice



**ZAPUŠTĚNÁ** matice  
s vnějším závitem



**MINI**  
matice



**MINI**  
matice



Redukce **RC-ADP**  
(více info na str. 4)



Tlak chladicího média  
**OLEJ**  
**EMULZE**  
≤ 100/150 bar



Typ **RCR**  
(více info na str. 4)

Tlak chladicího média  
**OLEJ**  
**EMULZE**  
≤ 100/150 bar

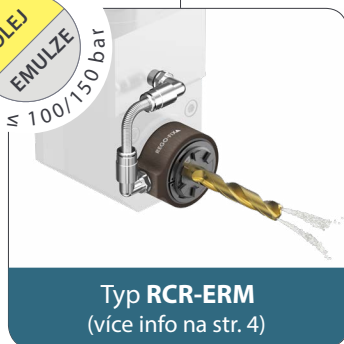

Typ **RCR-ERM**  
(více info na str. 4)

Tlak chladicího média  
**OLEJ**  
**EMULZE**  
≤ 100/150 bar

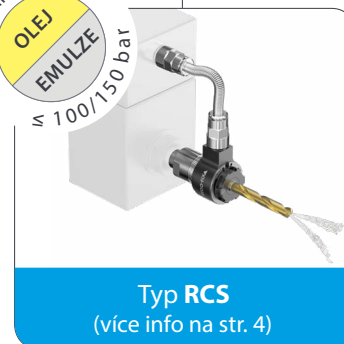

Typ **RCS**  
(více info na str. 4)

Velikost	Adaptér RCR	Adaptér RCR-ERM	Adaptér RCS
ER11	✓	✓	-
ER16	✓	✓	✓
ER20	✓	✓	✓
ER25	✓	✓	-
ER32	✓	-	-
ER40	✓	-	-

**i** Chladicí jednotky reCool® se dodávají bez kleštiny a nástroje.

# ► CO OBSAHUJÍ ZÁKLADNÍ SADY?

## A) SADY:

**RCR**

**RCR-ERM**

**RCS**

## B) REDUKCE:

**RC-ADP**

KAŽDÁ JEDNOTLIVÁ SADA obsahuje následující:

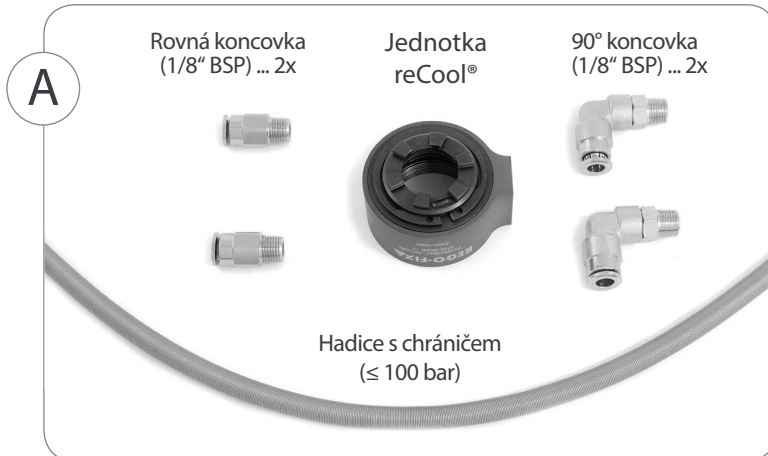







Více informací naleznete na straně 4.



Více informací naleznete na straně 4.

# ► CO DALŠÍHO BUDU POTŘEBOVAT ?

KLÍČE	ADAPTÉRY	TĚSNÍČÍ KROUŽKY	KLEŠTINY
Stránka 4 - 5	Stránka 6	Stránka 7	Stránka 8 - 11
	<p><b>1</b></p>  <p>Typ 1. Není nutno objednávat žádné adaptéry zvlášť.</p> <p><b>2</b></p>  <p>Typ 2. Nutno objednat <b>KULOVÝ ADAPTÉR.</b></p> <p>šroubek chladičí trubička s kuličkou</p> <p><b>3</b></p>  <p>Typ 3. Nutno objednat <b>HLINÍKOVÝ ADAPTÉR.</b></p> <p>chladičí trubička s kuličkou plastový kroužek</p>	 <p>pro <b>VNITŘNÍ</b> chlazení (DS/ER)</p>  <p>pro <b>OBVODOVÉ</b> chlazení (KS/ER)</p>	 <p>STANDARDNÍ</p> <p>↗ 0,010</p> <p>ULTRA PŘESNÉ</p> <p>↗ 0,005</p> <p><b>!</b></p> <p><b>NEPOUŽÍVAT TĚSNĚNÉ KLEŠTINY!</b></p>

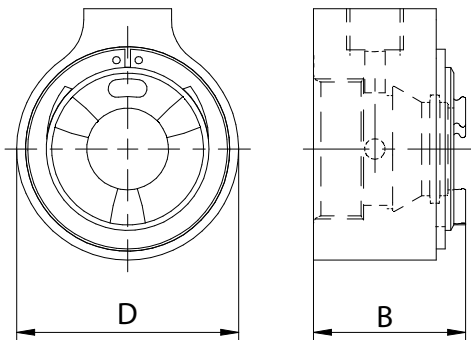

KAŽDÁ JEDNOTLIVÁ SADA obsahuje následující:

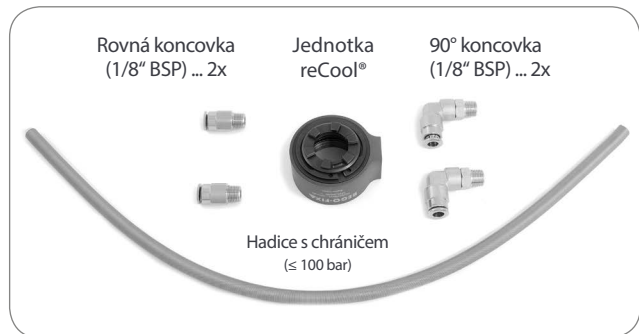

Typ	Velikost	Závit	D (mm)	B (mm)	Klíč	Objednací číslo	Standardní položka	
<b>RCR</b>	Rotační (OLEJ) (EMULZE)	ER 11	M 14 x 0,75	21,75	16,6	AX viz str. 5	3711.10000	<input checked="" type="checkbox"/>
		ER 16	M 22 x 1,5	34	24,5		3716.10000	<input checked="" type="checkbox"/>
		ER 20	M 25 x 1,5	40	26		3720.10000	<input checked="" type="checkbox"/>
		ER 25	M 32 x 1,5	50	27		3725.10000	<input checked="" type="checkbox"/>
		ER 32	M 40 x 1,5	62,5	29,5		3732.10000	<input checked="" type="checkbox"/>
		ER 40	M 50 x 1,5	72,5	32,5		3740.10000	<input checked="" type="checkbox"/>
<b>RCR ERM</b>	Rotační (OLEJ) (EMULZE)	ER 11	M 13 x 0,75	21,75	16,6	AX viz str. 5	3711.30000	<input checked="" type="checkbox"/>
		ER 16	M 19 x 1	31	24,5		3716.30000	<input checked="" type="checkbox"/>
		ER 20	M 24 x 1	38	26		3720.30000	<input checked="" type="checkbox"/>
		ER 25	M 30 x 1	46	27		3725.30000	<input checked="" type="checkbox"/>
<b>RCS</b>	Statická (OLEJ) (EMULZE)	ER 16	M 19 x 1	27,5	22,5	MX viz str. 5	3716.50000	<input checked="" type="checkbox"/>
		ER 20	M 24 x 1	34,5	24		3720.50000	<input checked="" type="checkbox"/>

⚠ Klíč je nutno objednat zvlášť.

## REDUKCE reCool®

Pro naháněné jednotky se zapuštěnou maticí s vnějším závitem

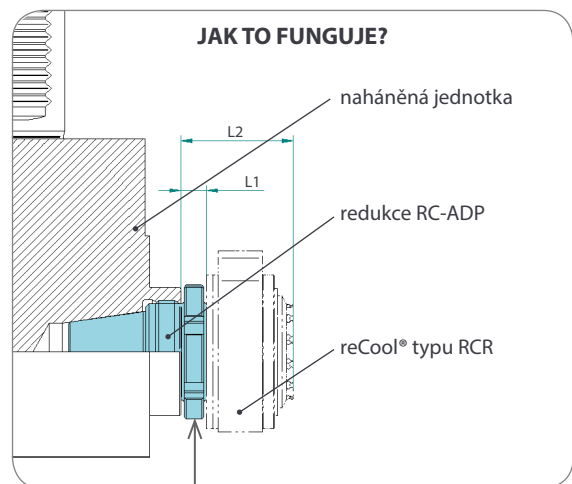

Typ	Velikost	L1 (mm)	L2 (mm)	závit 1	závit 2	Objednací číslo	Standardní položka	Klíč	Objednací číslo	Standardní položka
<b>RC-ADP</b>	ER 16	8,70	33,2	M 24 x 1	M 22 x 1,5	3799.81600	<input checked="" type="checkbox"/>		7112.16010	<input checked="" type="checkbox"/>
	ER 20	8,20	34,2	M 28 x 1,5	M 25 x 1,5	3799.82000	<input checked="" type="checkbox"/>		7112.20010	<input checked="" type="checkbox"/>
	ER 25	7,90	34,9	M 32 x 1,5	M 32 x 1,5	3799.82500	<input checked="" type="checkbox"/>		7111.25000	<input checked="" type="checkbox"/>
	ER 32	8,70	38,2	M 40 x 1,5	M 40 x 1,5	3799.83200	<input checked="" type="checkbox"/>		7111.32000	<input checked="" type="checkbox"/>
	ER 40	9,60	42,1	M 50 x 1,5	M 50 x 1,5	3799.84000	<input checked="" type="checkbox"/>		7111.40000	<input checked="" type="checkbox"/>

⚠ Klíč je nutno objednat zvlášť.

# UPÍNACÍ KLÍČE

RCR

RCR-ERM

- pro ROTAČNÍ jednotky

AX	Upínací klíče		Velikost	A (mm)	B (mm)	Objednáací číslo	Standardní položka
			ER 11	16,5	108	7117.11000	<input checked="" type="checkbox"/>
			ER 16	22	131	7117.16000	<input checked="" type="checkbox"/>
			ER 20	26	148	7117.20000	<input checked="" type="checkbox"/>
			ER 25	30	165	7117.25000	<input checked="" type="checkbox"/>
			ER 32	37	196	7117.32000	<input checked="" type="checkbox"/>
			ER 40	47	220	7117.40000	<input checked="" type="checkbox"/>
Upínací hlavice		Velikost	A (mm)	B (mm)	Objednáací číslo	Standardní položka	
		ER 11	16,5	62	7157.11000	<input checked="" type="checkbox"/>	
		ER 16	22	63	7157.16000	<input checked="" type="checkbox"/>	
		ER 20	26	64	7157.20000	<input checked="" type="checkbox"/>	
		ER 25	30	93	7157.25000	<input checked="" type="checkbox"/>	
		ER 32	37	95	7157.32000	<input checked="" type="checkbox"/>	
		ER 40	47	99	7157.40000	<input checked="" type="checkbox"/>	
Prodloužení		Velikost	D (mm)	L (mm)	Vnitřní (mm)	Objednáací číslo	Standardní položka
		ER 11	16,5	60	1/4"	7155.11000	<input checked="" type="checkbox"/>
		ER 16	22,5	80	1/4"	7155.16000	<input checked="" type="checkbox"/>
		ER 20	26	95	3/8"	7155.20000	<input checked="" type="checkbox"/>
		ER 25	29,5	105	1/2"	7155.25000	<input checked="" type="checkbox"/>
		ER 32	37,5	115	1/2"	7155.32000	<input checked="" type="checkbox"/>

**i** Pro prodloužení typu **V-E AX** je možné použít jenom **vnitřní čtyřhran**.

RCS

- pro STATICKÉ jednotky

MX	Upínací klíče		Velikost	A (mm)	B (mm)	Objednáací číslo	Standardní položka
			16	22,5	117,5	7118.16000	<input checked="" type="checkbox"/>
			20	29,0	129,5	7118.20000	<input checked="" type="checkbox"/>
	Upínací hlavice		Velikost	A (mm)	B (mm)	Objednáací číslo	Standardní položka
			16	22,5	56,5	7158.16000	<input checked="" type="checkbox"/>
			20	29,0	68,5	7158.20000	<input checked="" type="checkbox"/>
	Prodloužení		Velikost	D (mm)	L (mm)	Vnitřní o (mm)	Objednáací číslo
		16	22,5	80	1/4"	7159.16000	<input checked="" type="checkbox"/>
		20	29,0	95	1/4"	7159.20000	<input checked="" type="checkbox"/>

**i** Pro prodloužení typu **V-E MX** je možné použít klíč typu **E MX** i **vnitřní čtyřhran**.

## Momentový klíč TORCO-FIX pro upínací hlavice

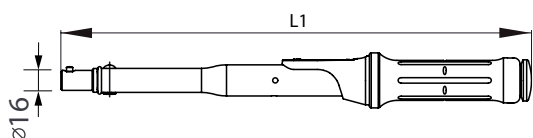

Objednáací číslo	Rozsah (Nm)	L1 (mm)	Standardní položka
4405-05	10-50 Nm	328	<input checked="" type="checkbox"/>
4410-01	20-100 Nm	376,5	<input checked="" type="checkbox"/>

# ▶ HADICE

## STANDARDNÍ

Hadice s chráničem (≤ 100 bar)

Typ	Objednací číslo	Standardní položka
	3799.95000	<input checked="" type="checkbox"/>

## ZVLÁŠTNÍ PŘÍSLUŠENSTVÍ

Vysokotlaké hadice s koncovkou 1/8" (≤ 150 bar)

Typ	L (mm)	Objednací číslo	Standardní položka
	100	3799.97100	<input checked="" type="checkbox"/>
	200	3799.97200	<input checked="" type="checkbox"/>
	300	3799.97300	<input checked="" type="checkbox"/>
	400	3799.97400	<input checked="" type="checkbox"/>

# ▶ KONCOVKY

90° koncovka

Typ	Objednací číslo	Standardní položka
RVA 	1/8" – 90° 3799.96189	<input checked="" type="checkbox"/>

• 2 kusy

Rovná koncovka

Typ	Objednací číslo	Standardní položka
RVG 	1/8" – 0° 3799.96180	<input checked="" type="checkbox"/>
	M8 x 1 – 0° 3799.96810	<input checked="" type="checkbox"/>

• 2 kusy

# ▶ ADAPTÉRY

Kulový adaptér 1/8" BSP

Typ	Objednací číslo	Standardní položka
RBA 	Ø 10.0 mm 3799.93100	<input checked="" type="checkbox"/>
	Ø 11.0 mm 3799.93110	<input checked="" type="checkbox"/>
	Ø 12.0 mm 3799.93120	<input checked="" type="checkbox"/>
	Ø 13.0 mm 3799.93130	<input checked="" type="checkbox"/>
	Ø 14.0 mm 3799.93140	<input checked="" type="checkbox"/>
	Ø 15.0 mm 3799.93150	<input checked="" type="checkbox"/>
	Ø 16.0 mm 3799.93160	<input checked="" type="checkbox"/>

Hliníkový adaptér 1/8" BSP

Typ	Objednací číslo	Standardní položka
RRA 	Ø 10.0 mm 3799.94100	<input checked="" type="checkbox"/>
	Ø 11.0 mm 3799.94110	<input checked="" type="checkbox"/>
	Ø 12.0 mm 3799.94120	<input checked="" type="checkbox"/>
	Ø 13.0 mm 3799.94130	<input checked="" type="checkbox"/>
	Ø 14.0 mm 3799.94140	<input checked="" type="checkbox"/>
	Ø 15.0 mm 3799.94150	<input checked="" type="checkbox"/>
	Ø 16.0 mm 3799.94160	<input checked="" type="checkbox"/>

# TĚSNÍCÍ KROUŽKY

## pro VNITŘNÍ chlazení (DS/ER)

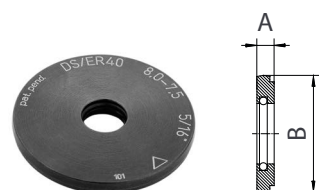
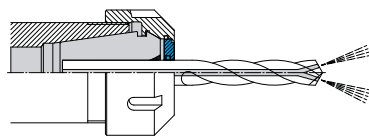

Typ	A (mm)	B (mm)
ER11	2,5	9
ER16	4	13
ER20	4	16
ER25	4	21
ER32	4	27
ER40	4	33,5

### MONTÁŽ

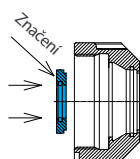

Pro montáž i demontáž použijte rovnoměrný tlak ve směru šipek.

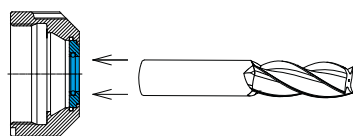

- NÁSTROJ vsuňte do těsnícího kroužku ZEPŘEDU.
- Při vsunutí nástroje z vnitřku matice může dojít k poškození O kroužku.

### DEMONTÁŽ

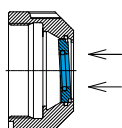

Velikost	Objednací číslo					
	ER11	ER16	ER20	ER25	ER32	ER40
3,00 - 2,50	3911.00300	3916.00300	3920.00300	3925.00300	3932.00300	3940.00300
3,50 - 3,00		3916.00350	3920.00350	3925.00350	3932.00350	3940.00350
4,00 - 3,50	3911.00400	3916.00400	3920.00400	3925.00400	3932.00400	3940.00400
4,50 - 4,00		3916.00450	3920.00450	3925.00450	3932.00450	3940.00450
5,00 - 4,50	3911.00500	3916.00500	3920.00500	3925.00500	3932.00500	3940.00500
5,50 - 5,00		3916.00550	3920.00550	3925.00550	3932.00550	3940.00550
6,00 - 5,50	3911.00600	3916.00600	3920.00600	3925.00600	3932.00600	3940.00600
6,50 - 6,00		3916.00650	3920.00650	3925.00650	3932.00650	3940.00650
7,00 - 6,50		3916.00700	3920.00700	3925.00700	3932.00700	3940.00700
7,50 - 7,00		3916.00750	3920.00750	3925.00750	3932.00750	3940.00750
8,00 - 7,50		3916.00800	3920.00800	3925.00800	3932.00800	3940.00800
8,50 - 8,00		3916.00850	3920.00850	3925.00850	3932.00850	3940.00850
9,00 - 8,50		3916.00900	3920.00900	3925.00900	3932.00900	3940.00900
9,50 - 9,00		3916.00950	3920.00950	3925.00950	3932.00950	3940.00950
10,00 - 9,50		3916.01000	3920.01000	3925.01000	3932.01000	3940.01000
10,50 - 10,00			3920.01050	3925.01050	3932.01050	3940.01050
11,00 - 10,50			3920.01100	3925.01100	3932.01100	3940.01100
11,50 - 11,00			3920.01150	3925.01150	3932.01150	3940.01150
12,00 - 11,50			3920.01200	3925.01200	3932.01200	3940.01200
12,50 - 12,00			3920.01250	3925.01250	3932.01250	3940.01250
13,00 - 12,50			3920.01300	3925.01300	3932.01300	3940.01300
13,50 - 13,00				3925.01350	3932.01350	3940.01350
14,00 - 13,50				3925.01400	3932.01400	3940.01400
14,50 - 14,00				3925.01450	3932.01450	3940.01450
15,00 - 14,50				3925.01500	3932.01500	3940.01500
15,50 - 15,00				3925.01550	3932.01550	3940.01550
16,00 - 15,50				3925.01600	3932.01600	3940.01600
16,50 - 16,00					3932.01650	3940.01650
17,00 - 16,50					3932.01700	3940.01700
17,50 - 17,00					3932.01750	3940.01750
18,00 - 17,50					3932.01800	3940.01800
18,50 - 18,00					3932.01850	3940.01850
19,00 - 18,50					3932.01900	3940.01900
19,50 - 19,00					3932.01950	3940.01950
20,00 - 19,50					3932.02000	3940.02000
20,50 - 20,00						3940.02050
21,00 - 20,50						3940.02100
21,50 - 21,00						3940.02150
22,00 - 21,50						3940.02200
22,50 - 21,00						3940.02250
23,00 - 22,50						3940.02300
23,50 - 23,00						3940.02350
24,00 - 23,50						3940.02400
24,50 - 24,00						3940.02450
25,00 - 24,50						3940.02500
25,50 - 25,00						3940.02550
26,00 - 25,50						3940.02600
Standardní položka	<input checked="" type="checkbox"/>	<input checked="" type="checkbox"/>	<input checked="" type="checkbox"/>	<input checked="" type="checkbox"/>	<input checked="" type="checkbox"/>	<input checked="" type="checkbox"/>

## pro OBVODOVÉ chlazení (KS/ER)

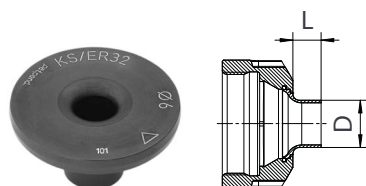
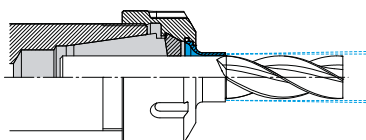

Montáž a demontáž probíhá jako u typu DS/ER.

Velikost	ER16			ER20			ER25			ER32		
	Objednací číslo	L (mm)	D (mm)	Objednací číslo	L (mm)	D (mm)	Objednací číslo	L (mm)	D (mm)	Objednací číslo	L (mm)	D (mm)
3	3916.20300	11	6,4	3920.20300	11	6,4	3925.20300	11	6,4	3932.20300	11	6,4
4	3916.20400	11	7,4	3920.20400	11	7,4	3925.20400	11	7,4	3932.20400	11	7,4
5	3916.20500	11	8,4	3920.20500	11	8,4	3925.20500	11	8,4	3932.20500	11	8,4
6	3916.20600	11	9,4	3920.20600	11	9,4	3925.20600	11	9,4	3932.20600	11	9,4
7	3916.20700	11	11	3920.20700	11	10,4	3925.20700	11	10,4	3932.20700	11	10,4
8	3916.20800	11	11	3920.20800	11	11,4	3925.20800	11	11,4	3932.20800	11	11,4
9	3916.20900	3	11	3920.20900	11	12,4	3925.20900	11	12,4	3932.20900	11	12,4
10	3916.21000	3	11	3920.21000	11	14	3925.21000	11	13,4	3932.21000	11	13,4
12				3920.21200	3	14	3925.21200	11	15,4	3932.21200	11	15,4
14							3925.21400	11	17,4	3932.21400	11	17,4
16							3925.21600	11	19	3932.21600	11	19,4
18										3932.21800	11	21,4
20										3932.22000	11	24
Standardní položka	<input checked="" type="checkbox"/>			<input checked="" type="checkbox"/>			<input checked="" type="checkbox"/>			<input checked="" type="checkbox"/>		

# ER KLEŠTINY (ER8-ER16)

↗ 0,010

SWISS MADE **REGO-FIX**



Upínací rozsah (mm)	ER 8 REGO-FIX®		ER 11 REGO-FIX®	
	Objednací číslo	Standardní položka	Objednací číslo	Standardní položka
1-0,5	1108.01000*	☑	1111.01000*	☑
1,5-1	1108.01500*	☑	1111.01500*	☑
2-1,5	1108.02000*	☑	1111.02000*	☑
2,5-2	1108.02500*	☑	1111.02500*	☑
3-2,5	1108.03000*	☑	1111.03000*	☑
3,5-3	1108.03500*	☑	1111.03500*	☑
4-3,5	1108.04000*	☑	1111.04000*	☑
4,5-4	1108.04500*	☑	1111.04500*	☑
5-4,5	1108.05000*	☑	1111.05000*	☑
5,5-5			1111.05500*	☑
6-5,5			1111.06000*	☑
6,5-6			1111.06500*	☑
7-6,5			1111.07000*	☑
Sady kleštin*	1108.00000 9-dílná	☑	1111.00000 13-dílná	☑

Upínací rozsah (mm)	ER 16 REGO-FIX®	
	Objednací číslo	Standardní položka
1-0,5	1116.01000*	☑
2-1	1116.02000*	☑
3-2	1116.03000*	☑
4-3	1116.04000*	☑
5-4	1116.05000*	☑
6-5	1116.06000*	☑
7-6	1116.07000*	☑
8-7	1116.08000*	☑
9-8	1116.09000*	☑
10-9	1116.10000*	☑
Sady kleštin*	1116.00000 10-dílná	☑

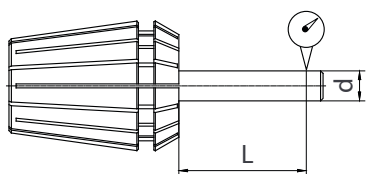

Porovnání házivosti ER kleštin: DIN x REGO-FIX®

Upínací průměr d (mm)		L (mm)	Maximální házivost (mm)	
>	≤		DIN 6499-B	REGO-FIX®
1,0	1,6	6,0	0,015	0,010
1,6	3,0	10,0		
3,0	6,0	16,0		
6,0	10,0	25,0		
10,0	18,0	40,0	0,020	
18,0	26,0	50,0		

Vliv házivosti upínání na životnost nástroje

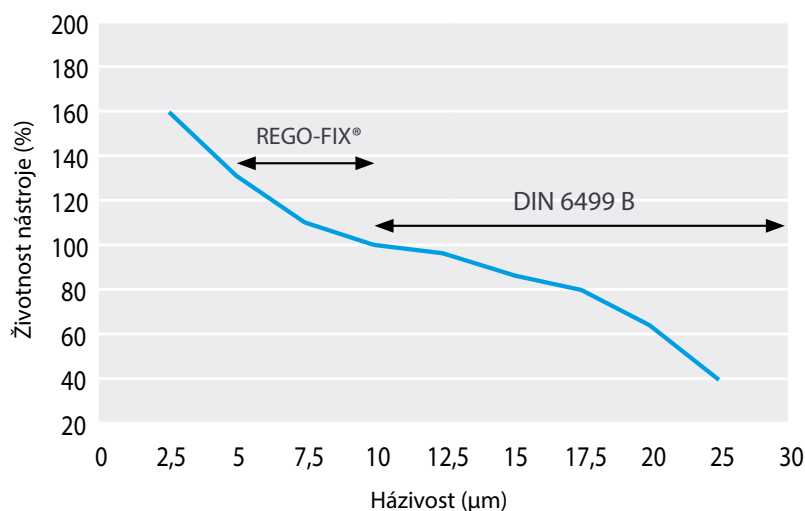

**1 μm ≈ 4%**

zvýšení házivosti    snížení životnosti nástroje



# ER KLEŠTINY (ER20-ER40)

↗ 0,010



SWISS MADE **REGO-FIX**

Upinací rozsah (mm)	ER 20 REGO-FIX®		ER 25 REGO-FIX®		ER 32 REGO-FIX®		ER 40 REGO-FIX®	
	Objednáací číslo	Standardní položka	Objednáací číslo	Standardní položka	Objednáací číslo	Standardní položka	Objednáací číslo	Standardní položka
1-0,5	1120.01000	☑	1125.01000	☑				
2-1	1120.02000*	☑	1125.02000*	☑	1132.02000	☑		
3-2	1120.03000*	☑	1125.03000*	☑	1132.03000*	☑	1140.03000	☑
4-3	1120.04000*	☑	1125.04000*	☑	1132.04000*	☑	1140.04000*	☑
5-4	1120.05000*	☑	1125.05000*	☑	1132.05000*	☑	1140.05000*	☑
6-5	1120.06000*	☑	1125.06000*	☑	1132.06000*	☑	1140.06000*	☑
7-6	1120.07000*	☑	1125.07000*	☑	1132.07000*	☑	1140.07000*	☑
8-7	1120.08000*	☑	1125.08000*	☑	1132.08000*	☑	1140.08000*	☑
9-8	1120.09000*	☑	1125.09000*	☑	1132.09000*	☑	1140.09000*	☑
10-9	1120.10000*	☑	1125.10000*	☑	1132.10000*	☑	1140.10000*	☑
11-10	1120.11000*	☑	1125.11000*	☑	1132.11000*	☑	1140.11000*	☑
12-11	1120.12000*	☑	1125.12000*	☑	1132.12000*	☑	1140.12000*	☑
13-12	1120.13000*	☑	1125.13000*	☑	1132.13000*	☑	1140.13000*	☑
14-13			1125.14000*	☑	1132.14000*	☑	1140.14000*	☑
15-14			1125.15000*	☑	1132.15000*	☑	1140.15000*	☑
16-15			1125.16000*	☑	1132.16000*	☑	1140.16000*	☑
17-16			1125.17000	☑	1132.17000*	☑	1140.17000*	☑
18-17					1132.18000*	☑	1140.18000*	☑
19-18					1132.19000*	☑	1140.19000*	☑
20-19					1132.20000*	☑	1140.20000*	☑
21-20					1132.21000	☑	1140.21000*	☑
22-21					1132.22000	☑	1140.22000*	☑
23-22							1140.23000*	☑
24-23							1140.24000*	☑
25-24							1140.25000*	☑
26-25							1140.26000*	☑
27-26							1140.27000	☑
28-27							1140.28000	☑
29-28							1140.29000	☑
30-29							1140.30000	☑
Sady kleštin*	1120.00000	☑	1125.00000	☑	1132.00000	☑	1140.00000	☑
	12-dílná		15-dílná		18-dílná		23-dílná	

Kleštiny označené \* u objednáacího čísla jsou obsaženy v příslušné sadě.

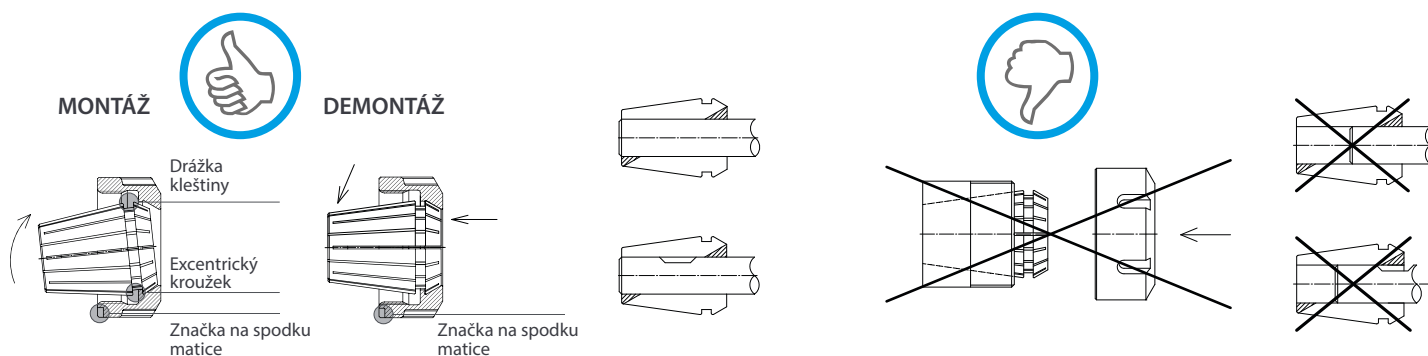

# ER-UP KLEŠTINY (ER8-ER16)

ULTRA PŘESNÉ

0,005

SWISS MADE **REGO-FIX**



Upínací rozsah (mm)	ER 8 - UP		ER 11 - UP	
	Objednací číslo	Standardní položka	Objednací číslo	Standardní položka
1-0,5	1108.01001*	☑	1111.01001*	☑
1,5-1	1108.01501*	☑	1111.01501*	☑
2-1,5	1108.02001*	☑	1111.02001*	☑
2,5-2	1108.02501*	☑	1111.02501*	☑
3-2,5	1108.03001*	☑	1111.03001*	☑
3,5-3	1108.03501*	☑	1111.03501*	☑
4-3,5	1108.04001*	☑	1111.04001*	☑
4,5-4	1108.04501*	☑	1111.04501*	☑
5-4,5	1108.05001*	☑	1111.05001*	☑
5,5-5			1111.05501*	☑
6-5,5			1111.06001*	☑
6,5-6			1111.06501*	☑
7-6,5			1111.07001*	☑
Sady kleštin*	1108.00001 9-dílná	☑	1111.00001 13-dílná	☑

Upínací rozsah (mm)	ER 16 - UP	
	Objednací číslo	Standardní položka
1-0,5	1116.01001*	☑
2-1	1116.02001*	☑
3-2	1116.03001*	☑
4-3	1116.04001*	☑
5-4	1116.05001*	☑
6-5	1116.06001*	☑
7-6	1116.07001*	☑
8-7	1116.08001*	☑
9-8	1116.09001*	☑
10-9	1116.10001*	☑
Sady kleštin*	1116.00001 10-dílná	☑

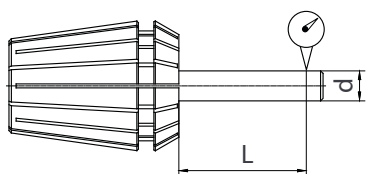

Porovnání házivosti ER kleštin: DIN x REGO-FIX®- UP

Upínací průměr d (mm)		L (mm)	Maximální házivost (mm)	
>	≤		DIN 6499-B	REGO-FIX® UP
1,0	1,6	6,0	0,015	0,005
1,6	3,0	10,0		
3,0	6,0	16,0		
6,0	10,0	25,0		
10,0	18,0	40,0	0,020	
18,0	26,0	50,0		

Vliv házivosti upínání na životnost nástroje

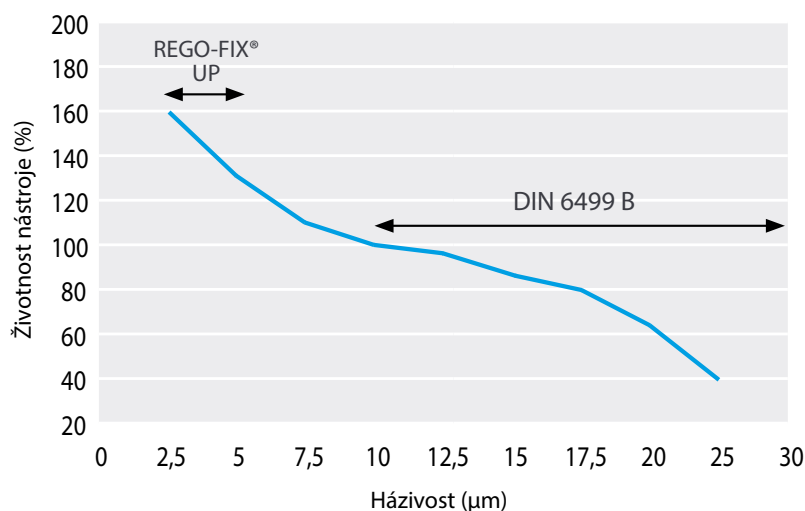

**1 μm ≈ 4%**

zvýšení házivosti    snížení životnosti nástroje

# ER-UP KLEŠTINY (ER20-ER40)

ULTRA PŘESNÉ

0,005



SWISS MADE **REGO-FIX**

Upínací rozsah (mm)	ER 20 - UP		ER 25 - UP		ER 32 - UP		ER 40 - UP	
	Objednací číslo	Standardní položka	Objednací číslo	Standardní položka	Objednací číslo	Standardní položka	Objednací číslo	Standardní položka
1-0,5	1120.01001	☑	1125.01001	☑				
2-1	1120.02001*	☑	1125.02001*	☑	1132.02001	☑		
3-2	1120.03001*	☑	1125.03001*	☑	1132.03001*	☑	1140.03001	☑
4-3	1120.04001*	☑	1125.04001*	☑	1132.04001*	☑	1140.04001*	☑
5-4	1120.05001*	☑	1125.05001*	☑	1132.05001*	☑	1140.05001*	☑
6-5	1120.06001*	☑	1125.06001*	☑	1132.06001*	☑	1140.06001*	☑
7-6	1120.07001*	☑	1125.07001*	☑	1132.07001*	☑	1140.07001*	☑
8-7	1120.08001*	☑	1125.08001*	☑	1132.08001*	☑	1140.08001*	☑
9-8	1120.09001*	☑	1125.09001*	☑	1132.09001*	☑	1140.09001*	☑
10-9	1120.10001*	☑	1125.10001*	☑	1132.10001*	☑	1140.10001*	☑
11-10	1120.11001*	☑	1125.11001*	☑	1132.11001*	☑	1140.11001*	☑
12-11	1120.12001*	☑	1125.12001*	☑	1132.12001*	☑	1140.12001*	☑
13-12	1120.13001*	☑	1125.13001*	☑	1132.13001*	☑	1140.13001*	☑
14-13			1125.14001*	☑	1132.14001*	☑	1140.14001*	☑
15-14			1125.15001*	☑	1132.15001*	☑	1140.15001*	☑
16-15			1125.16001*	☑	1132.16001*	☑	1140.16001*	☑
17-16			1125.17001	☑	1132.17001*	☑	1140.17001*	☑
18-17					1132.18001*	☑	1140.18001*	☑
19-18					1132.19001*	☑	1140.19001*	☑
20-19					1132.20001*	☑	1140.20001*	☑
21-20					1132.21001	☑	1140.21001*	☑
22-21					1132.22001	☑	1140.22001*	☑
23-22							1140.23001*	☑
24-23							1140.24001*	☑
25-24							1140.25001*	☑
26-25							1140.26001*	☑
27-26							1140.27001	☑
28-27							1140.28001	☑
29-28							1140.29001	☑
30-29							1140.30001	☑
Sady kleštin*	1120.00001	☑	1125.00001	☑	1132.00001	☑	1140.00001	☑
	12-dílná		15-dílná		18-dílná		23-dílná	

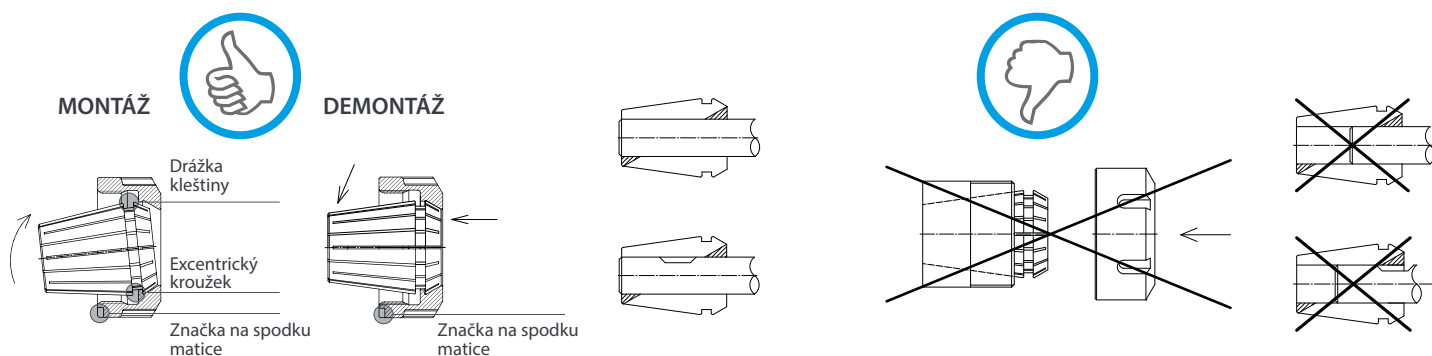

# TECHNICKÉ INFORMACE



CHLAZENÍ	OLEJ nebo EMULZE	
VISKOZITA	≤ ISO VG 46 (46 mm <sup>2</sup> /s 40 °C)	
FILTRACE	20 μm	
Pracovní TEPLOTA	10°C - 60°C	
MAX. OTÁČKY pro ROTAČNÍ jednotky	ER11 - ER32	12 000 ot/min.
	ER40	6 000 ot/min.
MAX. TLAK	Standardní HADICE	100 bar
	Vysokotlaká HADICE	150 bar

Ujistěte se před spuštěním reCool systému, zda chladicí kapalina proudí ven z nástroje nebo z těsnícího kroužku obvodového chlazení.

Tlak chladicí kapaliny nižší než je minimální (viz 1. tabulka), může způsobit nedostatečné chlazení a následné poškození reCool.

**Nikdy nenechte běžet reCool na sucho!**

Nedostatečný tlak chladicí kapaliny má za následek značné zhoršení chlazení nástroje a odvod třísek.

## 1. MINIMÁLNÍ TLAK CHLADICÍ KAPALINY PŘI PRÁCI S RECOOL

	TYP a VELIKOST jednotky reCool	STATICKÉ	ROTAČNÍ			
			≤ 3,000 ot/min.	≤ 6,000 ot/min.	≤ 9,000 ot/min.	≤ 12,000 ot/min.
STATICKE	RCS / ERMX 16	5 bar	-	-	-	-
	RCS / ERMX 20	5 bar	-	-	-	-
ROTAČNÍ	RCR-E&O / ER 11	-	5 bar	7,5 bar	10 bar	15 bar
	RCR-E&O / ER 16	-	5 bar	7,5 bar	10 bar	15 bar
	RCR-E&O / ER 20	-	5 bar	7,5 bar	10 bar	15 bar
	RCR-E&O / ER 25	-	5 bar	7,5 bar	10 bar	15 bar
	RCR-E&O / ER 32	-	5 bar	7,5 bar	10 bar	15 bar
	RCR-E&O / ER 40	-	5 bar	7,5 bar	-	-
	RCR / ERM 11	-	5 bar	7,5 bar	10 bar	15 bar
	RCR / ERM 16	-	5 bar	7,5 bar	10 bar	15 bar
	RCR / ERM 20	-	5 bar	7,5 bar	10 bar	15 bar
	RCR / ERM 25	-	5 bar	7,5 bar	10 bar	15 bar

## 2. DOPORUČENÝ UPÍNACÍ MOMENT

	VELIKOST		Průměr stopky (mm)	Doporučený upínací moment (Nm)
	ROTAČNÍ (RCR)	STATICKÉ (RCS)		
STANDARDNÍ matice	ER 11	-	3,0 – 6,0	24
			3,0 – 3,5	20
	ER 16	-	4,0 – 4,5	40
			5,0 – 10,0	56
	ER 20	-	3,0 – 6,5	32
			7,0 – 13,0	80
	ER 25	-	3,0 – 3,5	24
			4,0 – 4,5	56
			5,0 – 7,5	80
	ER 32	-	8,0 – 17,0	104
3,0 – 7,5			136	
ER 40	-	8,0 – 22,0	136	
		3,0 – 26,0	176	
MINI matice	ERM 11	-	3,0 – 3,5	16
	ERM 16	ERM 16	3,0 – 3,5	20
			4,0 – 10,0	24
	ERM 20	ERM 20	3,0 – 13,0	28
	ERM 25	-	3,0 – 3,5	24
4,0 – 17,0			32	