

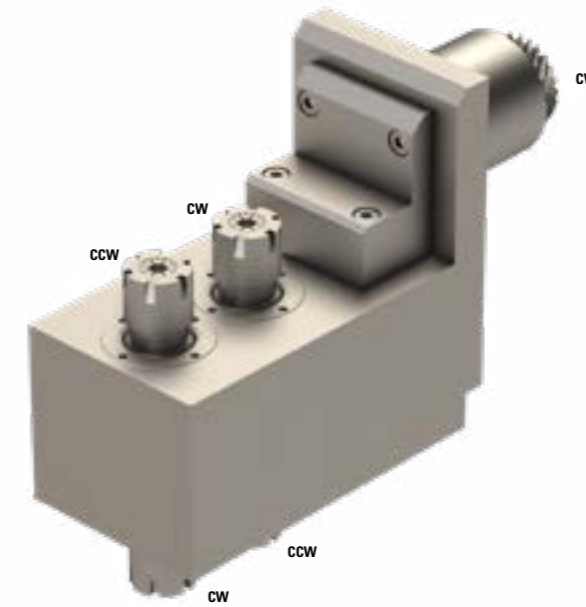

## STAR MICRONICS ST-20/ST-32

Face drill/mill tools	5
Cross drill/mill tools	6
Special tools	8



### SV20-TSE-010



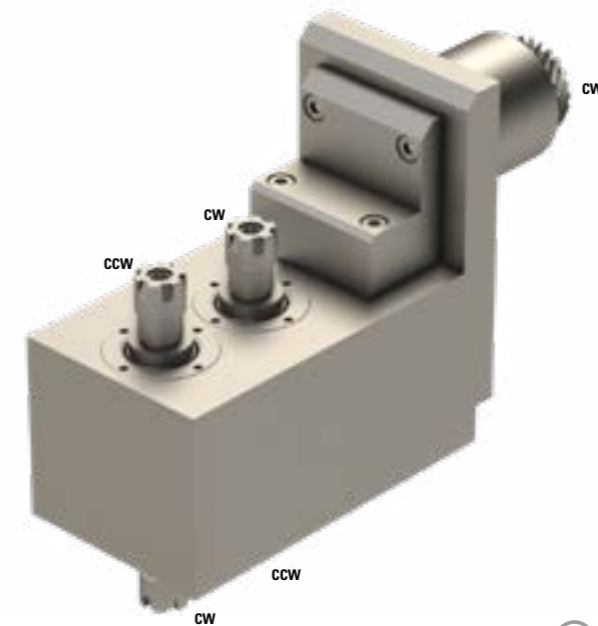

	2xER16+2xER16
	1:1
<b>RPM max.</b>	6'000
<b>Machines Types</b>	ECAS-20T ST-20 SV-20 SV-20R
<b>Note :</b>	

### SV20-TSE-207





	2xER11+2xER11
	1:1
<b>RPM max.</b>	6'000
<b>Machines Types</b>	ECAS-20T ST-20 SV-20 SV-20R
<b>Note :</b>	

Rotation: **cw** Clockwise    **ccw** Counterclockwise  
 Cooling:  INT Interior     EXT Exterior     Without

### SV20-TSC-210





	2xER16
	1:1
<b>RPM max.</b>	8'000
<b>Machines Types</b>	ECAS-20T ST-20 SV-12 SV-20 SV-20R
<b>Note :</b>	



### E20C-110-IK





	ER16
	1:1
<b>RPM max.</b>	6'000
<b>Machines Types</b>	ECAS-20T ST-20 SV-20 SV-20R
<b>Note :</b>	



### E20C-110-K



	ER16
	1:1
<b>RPM max.</b>	6'000
<b>Machines Types</b>	ECAS-20T ST-20 SV-20 SV-20R
<b>Note :</b>	



### SV20-901-AR



Ø	3xØ22
⚙️+⚙️	-
RPM max.	-
<b>Machines Types</b>	ECAS-20T ST-20 SV-12 SV-20 SV-20R
<b>Note :</b>	

