

RYCHLOPOSUVOVÉ série BX06

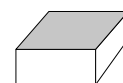

PLOCHY

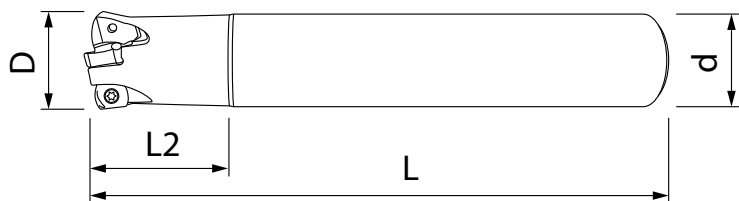
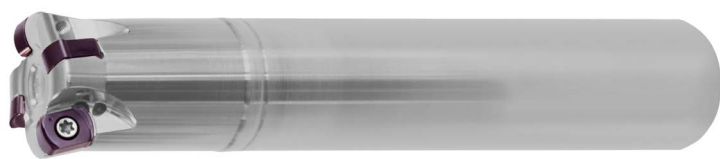
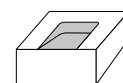

ZANOŘOVÁNÍ

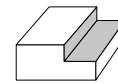

BOKY

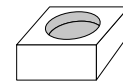

KRUHOVÉ
ZANOŘOVÁNÍ

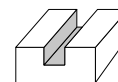

DRÁŽKY

NOVINKA

M2,5

Objednáací číslo	Sklad	D (mm)	Počet zubů	L (mm)		L2 (mm)	d h7 (mm)				Standardní položka
BX06-16-2-C16-L150	●	16	2	150	BXMX 0603..	30	16	✓	S-2506-EK	T8	☑
BX06-17-2-C16-L150	●	17	2	150		30	16	✓	S-2506-EK	T8	☑
BX06-20-3-C20-L150	●	20	3	150		30	20	✓	S-2506-EK	T8	☑
BX06-21-3-C20-L150	●	21	3	150		30	20	✓	S-2506-EK	T8	☑
BX06-25-4-C25-L150	●	25	4	150		35	25	✓	S-2506-EK	T8	☑
BX06-26-4-C25-L150	●	26	4	150		35	25	✓	S-2506-EK	T8	☑

● skladová položka

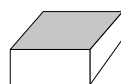
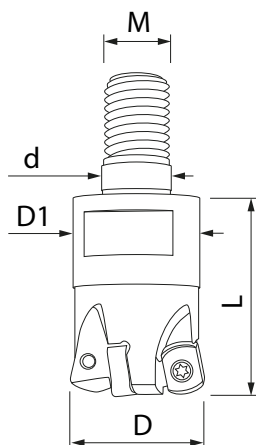

PLOCHY

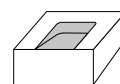

ZANOŘOVÁNÍ

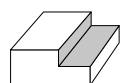

BOKY

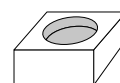

KRUHOVÉ
ZANOŘOVÁNÍ

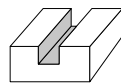

DRÁŽKY

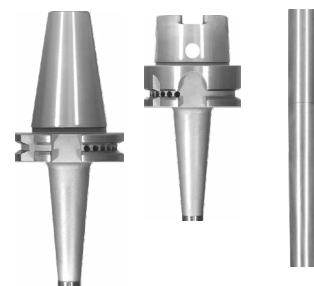

Nabídka na UPÍNAČE
Vám zašleme na vyžádání.

M2,5

Objednáací číslo	Sklad	D (mm)	Počet břitů	M (mm)		L (mm)	D1 (mm)	d (mm)					Standardní položka
BX06-16-2-M8	●	16	2	M8	BXMX 0603..	25	14	8,5	10	✓	S-2506-EK	T8	☑
BX06-20-3-M10	●	20	3	M10		30	18	10,5	15	✓	S-2506-EK	T8	☑
BX06-25-4-M12	●	25	4	M12		35	23	12,5	17	✓	S-2506-EK	T8	☑
BX06-32-5-M16	●	32	5	M16		43	29	17	22	✓	S-2506-EK	T8	☑
BX06-35-5-M16	●	35	5	M16		43	29	17	22	✓	S-2506-EK	T8	☑
BX06-40-6-M16	●	40	6	M16		43	29	17	22	✓	S-2506-EK	T8	☑
BX06-42-6-M16	●	42	6	M16		43	29	17	22	✓	S-2506-EK	T8	☑

● skladová položka

► RYCHLOPOSUVOVÉ série BX06

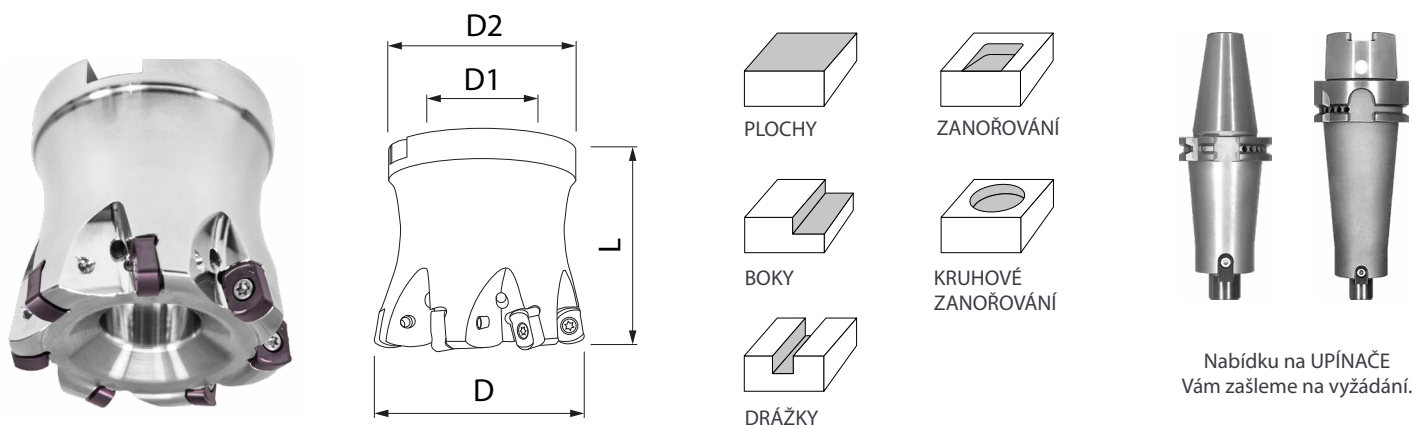

M2,5

Objednací číslo	Sklad	D (mm)	Počet břitů	D1 (mm)		L (mm)	D2 (mm)				Standardní položka
BX06-50-7-d22	●	50	7	22	BXXM 0603..	50	45	✓	S-2506-EK	T8	☑
BX06-52-7-d22	●	52	7	22		50	45	✓	S-2506-EK	T8	☑

● skladová položka

RYCHLOPOSUVOVÉ série BX09

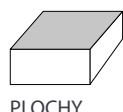
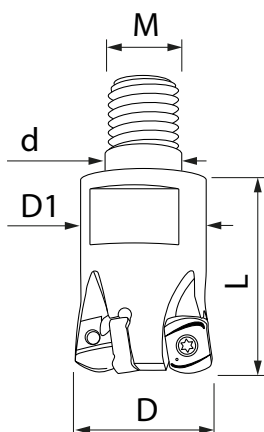

PLOCHY



ZANOŘOVÁNÍ

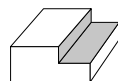

BOKY

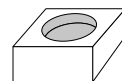

KRUHOVÉ
ZANOŘOVÁNÍ

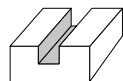



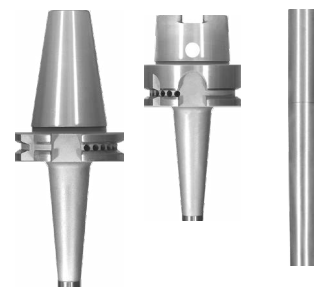

DRÁŽKY



Nabídku na UPÍNAČE
Vám zašleme na vyžádání.

M3,5

Objednací číslo	Sklad	D (mm)	Počet zubů	M (mm)		L (mm)	D1 (mm)	d (mm)					Standardní položka
BX09-25-3-M12	●	25	3	M12	BXXM 0904..	35	23	12,5	17	✓	S-3510-ET	T10	☑
BX09-32-3-M16	●	32	3	M16		43	29	17	22	✓	S-3510-ET	T10	☑
BX09-32-4-M16	●		4	M16		43	29	17	22	✓	S-3510-ET	T10	☑
BX09-35-4-M16	●	35	4	M16		43	29	17	22	✓	S-3510-ET	T10	☑
BX09-40-4-M16	●	40	4	M16		43	29	17	22	✓	S-3510-ET	T10	☑
BX09-42-5-M16	●	42	5	M16		43	29	17	22	✓	S-3510-ET	T10	☑

● skladová položka

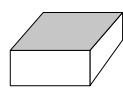
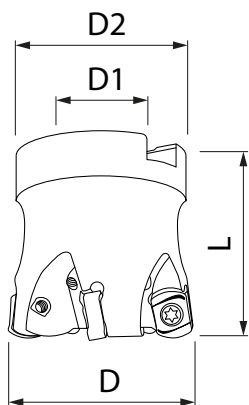

PLOCHY

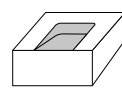

ZANOŘOVÁNÍ

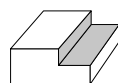

BOKY

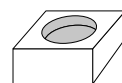

KRUHOVÉ
ZANOŘOVÁNÍ

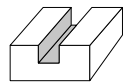

DRÁŽKY



Nabídku na UPÍNAČE
Vám zašleme na vyžádání.

M3,5

Objednací číslo	Sklad	D (mm)	Počet zubů	D1 (mm)		L (mm)	D2 (mm)				Standardní položka
BX09-50-5-d22	●	50	5	22	BXXM 0904..	50	46	✓	S-3510-ET	T10	☑
BX09-52-6-d22	●	52	6	22		50	46	✓	S-3510-ET	T10	☑
BX09-66-8-d27	●	66	8	27		50	58	✓	S-3510-ET	T10	☑

● skladová položka