

ZPĚTNÉ SOUSTRUŽENÍ

253S / 263S

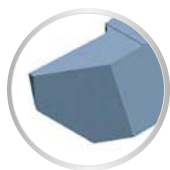
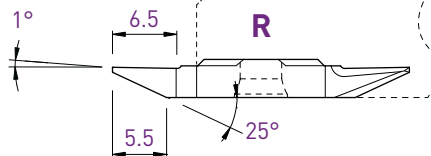
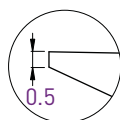
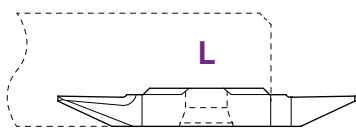

L				R			
Art. N°	AP302	AP202	Z	Art. N°	AP302	AP202	Z
253S05	■	□	■	263S05	■	□	■

■ = standardní položka
 □ = nestandardní položka (závisí na momentální situaci na skladě)

ZPĚTNÉ SOUSTRUŽENÍ

253 / 263

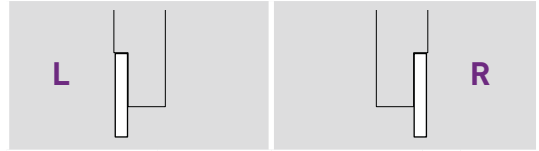
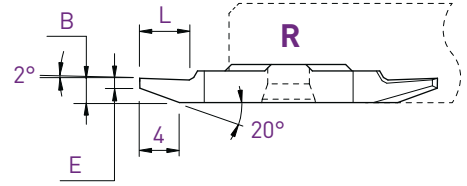
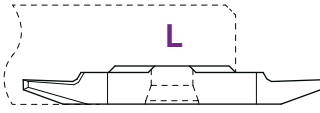

B	E	L	Art. N°	AP302	AP202	Z	Art. N°	AP302	AP202	Z
2.0	0.5	4	253-0.5	■	□	■	263-0.5	■	□	■
2.5	1.0	5	253-1.0	■	□	■	263-1.0	■	□	■

ZPĚTNÉ SOUSTRUŽENÍ

253X / 263X

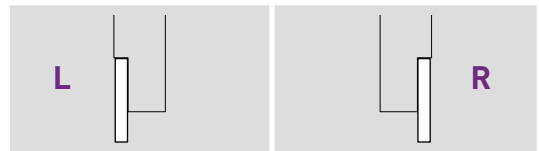
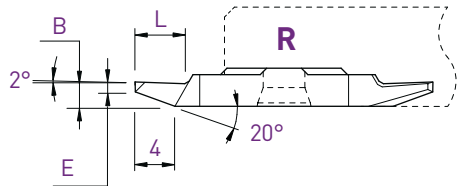
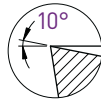
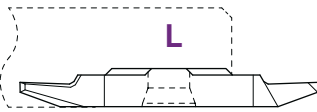

B	E	L	Art. N°	AP302	AP202	Z	Art. N°	AP302	AP202	Z
2.0	0.5	5	253X-0.5	■	□	■	263X-0.5	■	□	■
2.5	1.0	5	253X-1.0	■	□	■	263X-1.0	■	□	■

ZPĚTNÉ SOUSTRUŽENÍ

253VX-8° / 263VX-8°

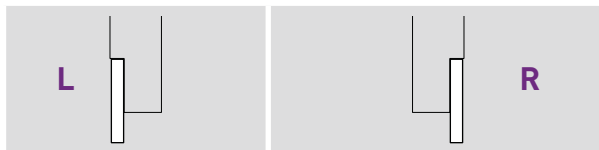
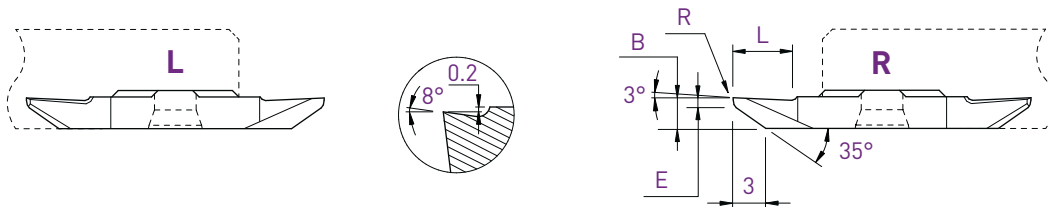

B	E	L	R	Art. N°	AP302	AP202	Z	Art. N°	AP302	AP202	Z	AH302	HN
3.1	1.0	6	0	253VX-8°	■	□	■	263VX-8°	■	□	■		
3.1	1.0	6	0.08	-				263VX-8°-R08	■	□	■	■	■
3.1	1.0	6	0.20	-				263VX-8°-R20	■	□	■	■	■

ZPĚTNÉ SOUSTRUŽENÍ

253VX-805 / 263VX-805

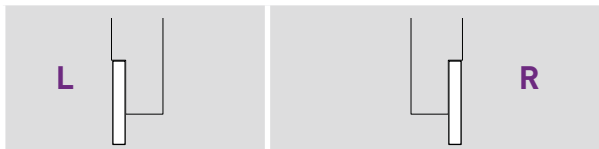
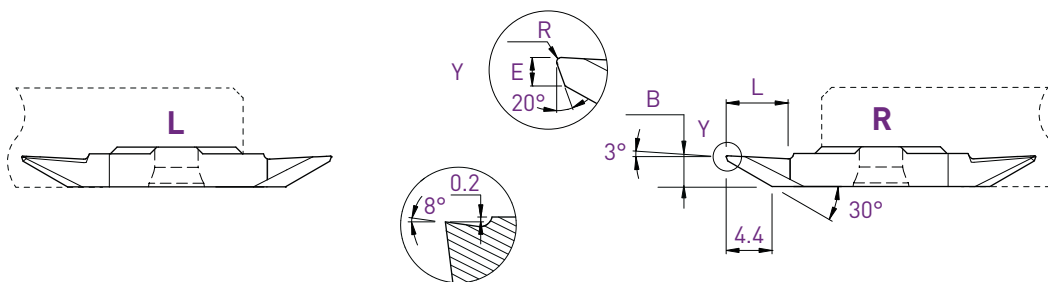

B	E	L	R	Art. N°	AP302	AP202	Z	Art. N°	AP302	AP202	Z	AH302	HN
3.0	0.5	6	0.08	253VX-805-R08	■	□	■	263VX-805-R08	■	□	■	■	■

■ = standardní položka
□ = nestandardní položka (závisí na momentální situaci na skladě)

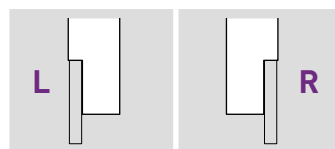
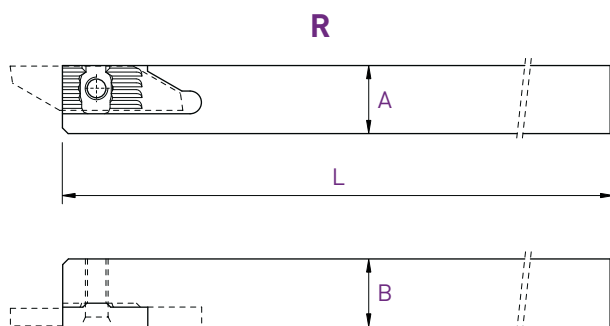

A x B	L	Art. N°	Art. N°
8 x 8	115	250-8	260-8
10 x 10	115	250-10	260-10
12 x 12	130	250-12	260-12
12 x 12	90	250-12-90	260-12-90
12.7 x 12.7	130	250-12.7	260-12.7
16 x 16	130	250-16	260-16
16 x 16	75	250-16-75	260-16-75
20 x 20	120	250-20	260-20

Šroubky a klíč jsou součástí každého držáku

DRŽÁKY

260-C

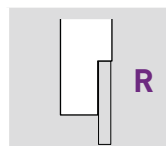
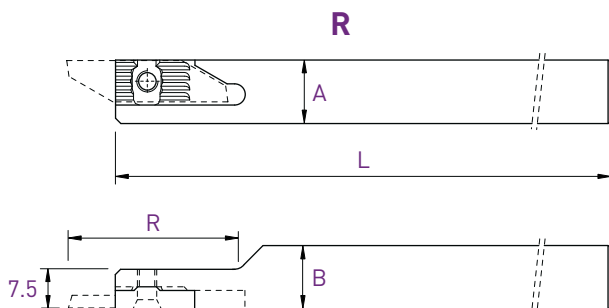
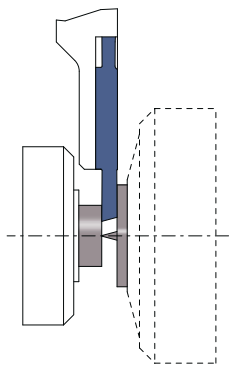

A x B	L	R	Art. N°
12 x 12	130	30	260-C-12

DRŽÁKY

Upichování v pravé linii

250RC

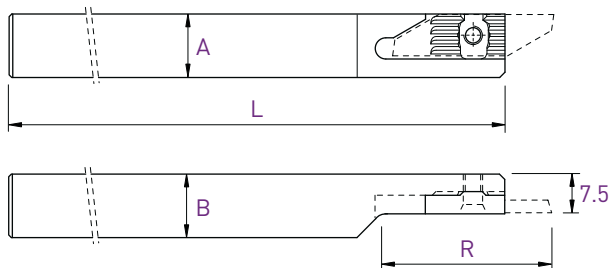
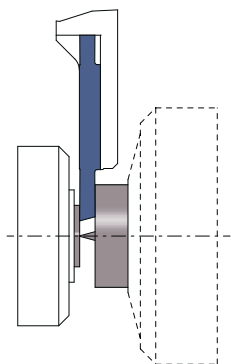

L (R)			Art. N°
Upichování v pravé linii			
A x B	L	R	

12 x 12	130	30	250RC-12
16 x 16	130	40	250RC-16

Pro destičky typu 251R



Šroubky a klíč jsou součástí každého držáku

DRŽÁKY S VNITŘNÍM CHLAZENÍM

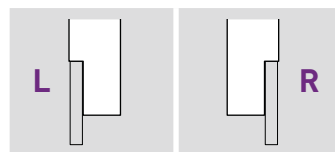
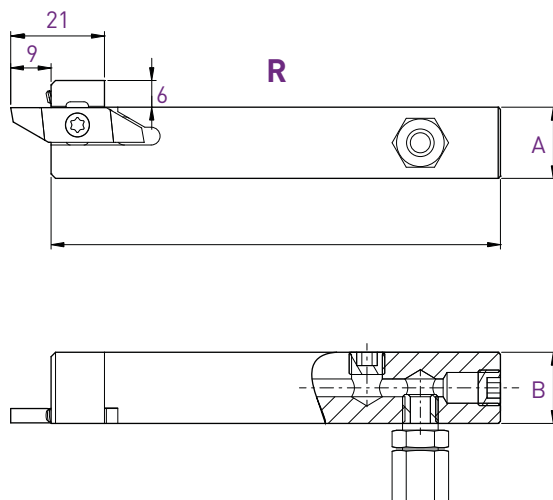
250-JET / 260-JET



A x B	L	Art. N°	Art. N°
10 x 12	100	250-1012-JET	260-1012-JET
12 x 12	100	250-12-JET	260-12-JET
16 x 16	100	250-16-JET	260-16-JET
20 x 20	100	250-20-JET	260-20-JET

Náhradní díly			Tryska 
	Art. N°	Art. N°	Art. N°
250-JET / 260-JET	J-M8X1-D6	JB-M8X1	JJ-M3X6-D1.5

Šroubky a klíč jsou součástí každého držáku

DRŽÁKY

260/250F

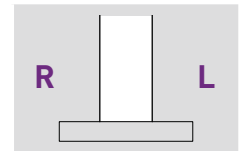
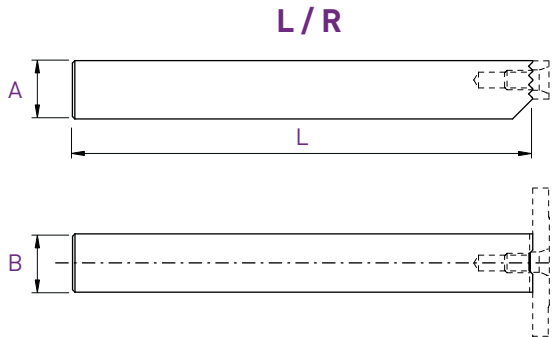

A x B	L	Art. N°
10 x 12	120	260/250F-1012
12 x 12	120	260/250F-1212

DRŽÁKY

260/250-D

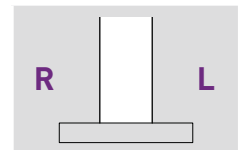
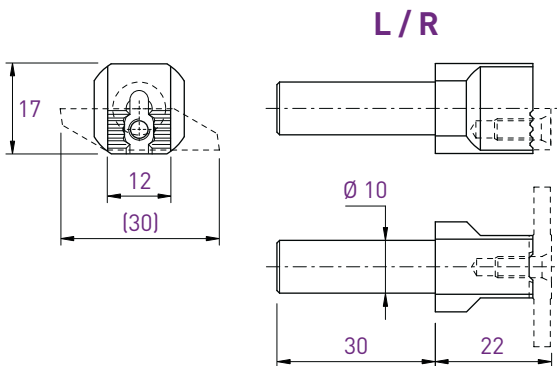

Art. N°
260/250-D10

Šroubky a klíč jsou součástí každého držáku

SORTY

<p>AP302 μK20 + PVD povlak</p>	<p>AP202 μK20 + PVD povlak</p>	<p>N (μK20) nepovlakovaný</p>
<ul style="list-style-type: none"> • nejlepší univerzální sorta • první volba pro obrábění ocelí, nerezových ocelí a slitin titanu • velmi dobrá tepelná odolnost 	<ul style="list-style-type: none"> • sorta vhodná zejména pro nízké řezné rychlosti 	<ul style="list-style-type: none"> • vhodné pro přerušovaný řez a nestabilní podmínky obrábění

<p>AH302 μK10 + PVD coating</p>	<p>HN (μK10) nepovlakovaný</p>
<ul style="list-style-type: none"> • sorta velmi odolná proti opotřebení • pro lehké obrábění ocelí, nerezových ocelí a titanu za stabilních podmínek 	<ul style="list-style-type: none"> • mikrozmrný tvrdkov odolný proti opotřebení • vhodný pro obrábění nízkolegovaného titanu • není vhodné pro přerušovaný řez a nestabilní podmínky obrábění

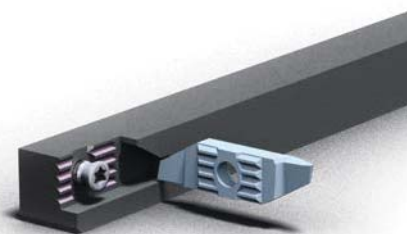



Patentovaný tuhý upínací systém

STANDARDNÍ ŘEZNÉ PODMÍNKY

MATERIÁL	SOUSTRUŽENÍ		UPICHOVÁNÍ	
	VC (m/min)	F (mm/otáčku)	VC (m/min)	F (mm/otáčku)
Automatové oceli (P)	120 - 200	0.01 - 0.20	80 - 150	0.01 - 0.15
Oceli < 600 N/mm ² (P)	80 - 160	0.01 - 0.18	70 - 120	0.01 - 0.12
Oceli < 800 N/mm ² (P)	60 - 120	0.01 - 0.15	60 - 100	0.01 - 0.10
Oceli > 800 N/mm ² (P)	50 - 100	0.01 - 0.12	40 - 80	0.01 - 0.08
Nerezové oceli (M)	60 - 120	0.01 - 0.15	60 - 100	0.01 - 0.08
Hliník (N)	180 - 800	0.01 - 0.30	150 - 300	0.01 - 0.20
Měď, mosaz, bronz (N)	100 - 500	0.01 - 0.30	100 - 300	0.01 - 0.20
Titan (S)	30 - 70	0.01 - 0.12	30 - 50	0.01 - 0.06

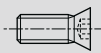
PŘÍSLUŠENSTVÍ

Držáky			Další možnost Art. N°
250-8 / 260-8	V-M3.5X7.3-T15	C-T15	SET-NM-TX15
250-... / 260-...	V-M4X9-T15		
250RC / 260-C	V-M4X7.3-T15		

Doporučení upínací moment

3.0 Nm



SET-NM-TX15